

2017 - 2018

Hassay Savage



Precision Broaches for Every Application



MADE IN THE
USA



Hassay Savage Company • 3 Great Programs, One Great Company!



Let us be your partner in unique cutting applications!

www.hassay-savage.com



www.hassay-savage.com



**Unique,
Precision
Cutting Tools!**



NEW 8760 Series Blind Hole Reamers w/Coolant

www.hassay-savage.com

Hassay Savage • GMauvais • Magafor Sales Representatives & US Warehouse Locations

Hassay Savage takes great pride in providing outstanding customer service. We ship from warehouses in

Turners Falls, MA • Anaheim, CA

We provide sales and technical support services nationwide.

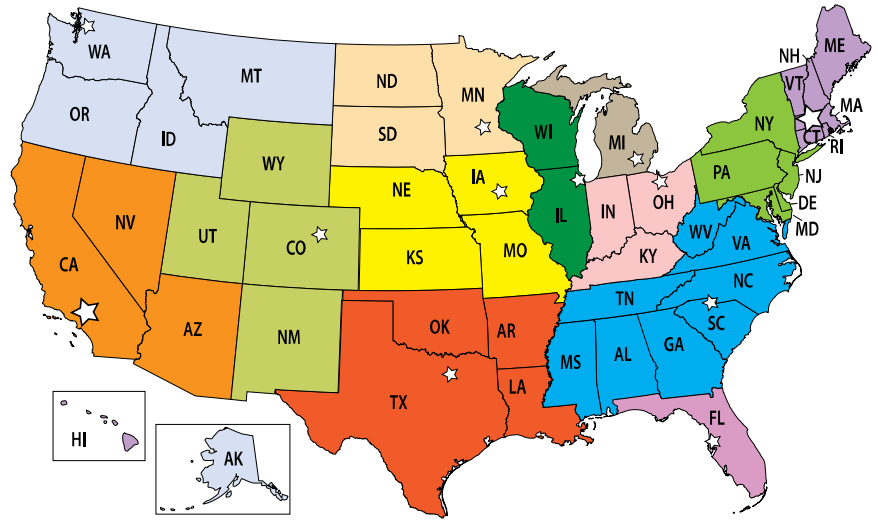

TURPIN SALES & MARKETING

330 Cold Springs Road
West Springfield, MA 01089
www.turpinsales.com
Email: dturpin@turpinsales.com
Phone: 413-733-6700
Fax: 413-747-2600
CT, MA, ME, NH, RI, VT

A J HANSON & COMPANY

203 S. Orcas Street
Seattle, WA 98108
www.ajhanson.com
Email: ajhco@ajhanson.com
Phone: 206-763-8550
Fax: 206-762-6246
WA, OR, ID, MT, AK

COAST INDUSTRIAL SALES

1630 S. Sunkist Street
Unit T
Anaheim, CA 92806
Email: coastind@pacbell.net
Phone: 714-282-6711
Fax: 714-637-1891
CA, NV, AZ

PTI, INC.

3271 South Magnolia Street
Denver, CO 80224
Email: ptidenver@msn.com
ptisaltlake@msn.com
Phone: 303-808-5311
Fax: 303-757-0092
CO, WY, UT, NM

TOM PAINE GROUP

5640 Joshua Court
Mansfield, TX 76063
www.tompainegroup.com
Email: tom@tompainegroup.com
Phone 817-296-6258
TX, OK, AR, LA

BRAASCH INDUSTRIAL SALES

9103 Vickors Crossing N.
Brooklyn Park, MN 55443
Email: reidswans@msn.com
Mobile: 612-281-7476
www.knowledgeandservice.com
MN, ND, SD

FACTORY TOOLING SOLUTIONS

1305 NW Parkridge Place
Ankeny, IA 50023
www.factorytoolingsolutions.com
Email: kbeav@msn.com
Phone: 515-249-3549
Fax: 515-965-0966
IA, NE, KS, MO

SURPLESS, DUNN & COMPANY

2150 West Lawrence Ave.
Chicago, IL 60625
www.surplessdunn.com
info@surplessdunn.com
Phone: 800-621-5117
Fax: 800-329-7301
IL, WI

CLEARWATER DIST. ADVISORS

885 N. Skokie HWY, Suite K
Lake Bluff, IL 60044
sergio.pappa@cwdainc.com
Phone: 847-295-7371
Fax: 847-295-7373
Cell: 847-527-7662
SPECIAL DISTRIBUTION

EAGENS TOOLING SOLUTIONS

350 S. Main Street, Ste. 115
Doylestown, PA 18901
www.eagens.com
Email: meagen@eagens.com
Phone: 215-378-6404
Fax: 215-345-9480
NY, DE, MD, DC, NJ, PA, WV

RON WALLACE & ASSOCIATES

1201 Old North Main Street
Clover, SC 29710
www.rwamktg.com
Email: rwamktg@rwamktg.com
Phone: 803-222-3562
Fax: 803-222-1338
SC, VA, NC, GA, AL, TN, MS

R.A.M. SALES & MARKETING

13029 Sugar Creek Blvd
Hudson, FL 34669
www.ramsalesandmarketing.com
bob@ramsalesandmarketing.com
Phone: 727-856-6131
Fax: 727-856-6638
FL

TEK-REP GROUP, INC.

817 Eliza Court
Brunswick, OH 44212
Email: larry@tekrepgroup.com
Phone: 330-220-1116
Fax: 330-273-0121
OH, IN, KY

International Agencies:

Hassay Savage has partnered with select distributors in over 28 countries committed to our outstanding ingenuity and quality in all broaching applications. Please contact our home office for information on a Hassay Savage distributor in our growing network:

Australia, Belgium, Canada, Denmark, England, Finland, France, Germany, Greece, Holland, Ireland, Israel, Italy, Korea, Mexico, New Zealand, Russia and South Africa.

Hassay Savage

Your Total Broach Company!

Broaches For Every Application...

Medical

Orthopedic

Dental

Automotive

Firearms

Munitions

Military

Aircraft

Aerospace

Electronics

Communications

Plastics

HISTORY

Founded in 1969, Hassay Savage is a U.S. based, family owned company with designers and manufacturers of precision broaches dedicated to:

- Fine craftsmanship
- State-of-the-art design and equipment
- Computerized and process manufacturing (CNC and CAD/CAM)
- Thorough process control and process analysis (SPC)
- Dedicated tradeshow attendance



SPECIALIZATION

- Comprehensive high-speed steel broaching tools: Keyways, Squares, Hex, CNC and a variety of Unique Shapes
- Critically accurate cuts for many configurations Producing extraordinary smooth surface finishes
- World's finest push, pull and rotary broaches
- Complete breadth of line in standard broaches from stock
- Best turnaround times in the industry



PERSONALIZED SERVICE

Meet your product goals while increasing your profit margin!

We provide:

- Profit Improvement Programs (PIP)
- Cost analysis of broaching versus other machining processes
- Solutions from standard stock or custom broaches for your unique applications
- Complete turnkey design

Let us be your partner in your unique cutting applications!



Hassay Savage • GMauvais • Magafor

10 Industrial Blvd., Turners Falls, MA 01376-2251 • Phone: 413-863-9371 • Fax: 413-863-2714 • info@hassay-savage.com

TOLL FREE: 1-800-247-2024 • www.hassay-savage.com



TABLE OF CONTENTS

Sales Representatives & US Warehouse Locations 3
 What is Broaching? 6
 Broaching Processes and Tools 7

ORDERING

Request For Quote Form 8

KEYWAY BROACHES & SETS

Keyway Broaches Overview 9
 Keyway Broach American Inch Standard Sets 10
 Heavy Duty Keyway Broach Sets 11
 Keyway Broach Metric Sets 12
 Keyway Broach DIN Metric Sets 13
 American Inch Standard Keyway Broaches 14-15
 Standard Metric Keyway Broaches ISO-JS 9 16-17
 Standard Metric Keyway Broaches ISO-P9 18
 One Pass Keyway Broaches 18

CNC SINGLE POINT KEYWAY

Inch and Metric Shank Specifications 19

ROTARY BROACHING

Hexagonal Rotary Punch Broaches M-2 20
 Hexagonal Rotary Punch Broaches M-42 21
 Square Rotary Punch Broaches 22
 Adjustable Rotary Broach Holders 23
 Rotary Broaching Set-Up Plugs 24
 Swiss Style Rotary Punch Broaches 24
 Swiss Style Non-Adjustable Holders 25
 Use Recommendations 26

INDEX BROACHING

Square, 2 Point Hex, 4 Point Hex, & 6 Lobe Broach Cutting ... 27-28
 Quick Change Punch & Index Broach Holder Systems 28-29
 Index Broach Quote Form 29

PUSH BROACHES

Inch Square & Full Square Push Broaches 30
 Hexagonal Push Broaches 31

DAVIS STYLE KEYSEATING

Inch & Standard Metric Sizes 32

500 & 600 SERIES PULL TYPE

500 & 600 Series Pull Type Broaches 33

CUSTOM BROACHING SOLUTIONS

Custom & Special Broaches 34-36



KEYWAY BROACHES & SETS

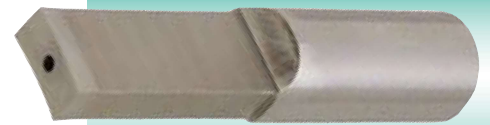

CNC SINGLE POINT KEYWAY



ROTARY BROACHING



INDEX BROACHING



PUSH BROACHES

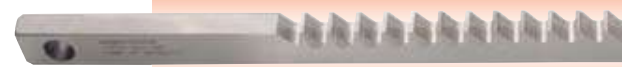

DAVIS STYLE KEYSEATING



500 & 600 SERIES PULL TYPE



CUSTOM BROACHES

What is Broaching?

Broaching is a progressive metal-cutting process which incorporates a series of roughing, semi-finishing, and finishing teeth designed to remove successive portions of stock as the tool moves through or across a workpiece in a one-pass linear operation. Each tooth is calibrated to remove only a small amount of stock appropriate to the type of material broached, which permits continuous clean chip cutting.

BROACHING ORIGINATED with the venerable blacksmith 3,000 years ago. He needed to create internal spaces within the pieces he hand-forged. The blacksmith invented **DRIFTS** in varieties of configurations to punch these shapes. Drifts were driven by hammer through the cherry-red hot metal held on the primitive anvil over the pritchel or hardy hole to form a variety of internal shapes.

MODERN BROACHING dates back to mid-nineteenth century Germany, where the drifting tool incorporated a series of uniform cutting teeth to remove material (much like a wood rasp). These **FIRST BROACHES** were short heavy hand-driven push tools. Initially, internal broaching, such as cutting keyways in pulleys and gears, accounted for the bulk of the work done, and as the power press was developed, applications for internal broaching widened.

SURFACE BROACHING evolved more slowly, but by the 1920's became critical in meeting the demands of mass production in the **AUTOMOTIVE INDUSTRY**. By the 1930s broaching processes

could supply the industry with close-tolerance square holes and multiple splines for transmission gears. The technology continued to develop into spiral spline broaching, tooth cutter bars, and broaches manufactured from **HIGH-SPEED STEEL**. By the mid-50's hydraulic, fully automatic internal and external broaching machines were in wide use, making it possible to reduce the cost of mass producing accurately finished identical parts of all shapes and sizes.



Pictured: A broaching operation using Hassay Savage push broaches.

BROACHING FIXTURES typically incorporate mechanical, hydraulic or pneumatic principles and utilize programmable controls and automatic clamping for continuous cycle indexing.

COMPUTERS increasingly play a vital role in the design and manufacturing set-up of broach toolmaking. The industry also asserts its competitive edge by taking advantage of significant technical advances in the fields of grinding, coolants, lubricants, stock materials, and heat treatment; which make it possible to produce a tougher, sharper tool at less cost and with faster turnaround.



SINCE 1969, HASSAY SAVAGE COMPANY has emerged as the leader in the development of broaching applications into many areas of manufacturing where there is need to produce precise complex shapes and forms. Forty-eight years later, we are convinced that by joining **STATE-OF-THE-ART** technologies with the **CRAFT** of broaching as it has evolved, modern broaching heads into the twenty-first century as a competitive alternative to milling, reaming and shaping in operations where critical tolerances and high production speeds of manufactured parts are required.

Broaching Processes and Tools

Classified first as **SURFACE** or **INTERNAL**, then as **STANDARD** or **SPECIAL**, each broaching tool is designed and manufactured to fit the specified print. Its length of cut, LOC, and number of teeth are set by the type of stock (i.e. - machined, cast, or forged) and amount of metal to be removed. Hassay Savage presents a comprehensive line of high-speed steel broaching tools capable of critically accurate performance in many configurations while producing extraordinarily smooth surface finishes.

Surface Broaches



Surface broaching is most commonly used in place of milling or shaping operations on surfaces of parts or components.

The tool is a simple flat bar with multiple rows of cutting teeth, usually attached by bolting or clamping onto a broach holder.

- Surfaces may be flat, concave, convex, serrated, or cam-shaped
- Can be manufactured as insert sections and configured in a broach holder, lowering costs of initial manufacturing and replacement
- Produce highly finished surfaces of complex shapes with exacting dimensions and tolerances
- Production rates can be many times faster than milling or machining processes

Applications Include:

- Flats
- Intricate Contours
- Slots
- External Gearing
- Notches
- Serrations
- Key Lock Slots
- Turbine Forms
- Connecting Rods



Internal Broaches



Starting with a round drilled hole, internal broaching can mass produce practically any internal hole configuration from the simplest to the most complicated.

Pull broaches significantly remove more stock than push broaches, even where the workpiece has a thin or irregular wall, and can handle longer lengths of cut.

Faster and more economical than other machining processes. All these derivative shapes generate internal gear splines, helical splines, and other irregular shapes.

Tools Include:

- Square
- Hex
- Round Helical Cut
- Straight Spline and Serration
- Involute Spline and Serration
- Combination Keyway & Bore Sizing

Internal broaching solves scores of manufacturing applications that simply cannot be done any other way. For instance, there is no other way to make a precise square hole.

Applications Include:

- Tooling Fixtures
- Keyways
- Gear & Pulley Keyways
- Hole Configurations in all Geometric Shapes



Standard Broaches



Pictured: Standard push keyway broach and guide system bushing; for 1/4 keyway for an idler mechanism

The strength of our business at Hassay Savage has been built upon standard broaches available from stock and **SHIPPED ON THE SAME DAY THE ORDER IS PLACED**. We are one of a very few broach manufacturers who sell standard tools from stock, which means we can satisfy our customers' needs immediately.

Our sophisticated system of market distribution (400 industrial distributors and 2 factory warehouse locations) permits product to be in the customer's plant when most needed.

Special Broaches

The Hassay Savage design and engineering departments offer a complete line of services for production of special broaches. Our engineers can integrate the design and manufacturing process of your custom broach, while working with you to meet your product goals and increase your profit margin.

See page 34-36 for Custom Broaching Solutions.





Hassay Savage

24 Hour Fax: 413-863-2714 • Telephone: 1-800-247-2024

Email: info@hassay-savage.com • www.hassay-savage.com

See form on page 29 for Rotary and Index broaching applications

Request For Quote Form

Customer Information

Name _____

Title _____

Company Name _____

Street Address _____

Address line 2 _____

City _____ State _____ Zip _____

Telephone _____ FAX _____

Email _____ Country _____

Broaching Information

Size & Shape of Cut _____

Length of Cut _____ Tolerance _____

Material to be Broached _____

Pre-Broaching Condition of Hole Surface:

Pilot Hole Size _____

Hole Size (for cast holes) _____

(Include draft/fillet radii, if any)

For Keyway Broaches:

Bore Size _____ Keyway Width _____

Tolerance _____ Length of Cut _____

Depth of Keyway, measured across Bore _____

Type of Broaching Machine:

Push Pull Tonnage _____ Ram Travel _____

Daylight Opening _____

PULL ENDS



Please Provide This Information

Pull End No. _____

Size _____

Distance to 1st Tooth _____

Starting Hole Size _____

Finish Size _____

Length of Cut _____

Material _____

Remarks _____

Straight, Serration, or Involute Spline Information (Include Part Print):

Inv. Std. _____

No. of Splines _____

Diametrical Pitch _____

Pressure Angle _____

Major Dia. _____

Minor Dia. _____

Measurement Between Wires _____

Wire Size _____

Circular Tooth Thickness _____

The Hassay Savage WARRANTY

Hassay Savage Tools are warranted free from defects in material and workmanship in all cases of normal use. If under conditions of normal use a tool fails, it shall be repaired or replaced, at our option, when shipped prepaid to our factory in Turners Falls, Massachusetts 01376.

This warranty is made in lieu of all other warranties expressed or implied. This warranty does not cover tools which have been stamped for identification, experimented upon, or otherwise modified, or tools which after examination prove to have been abused, or are without flaws in material or workmanship. Government regulations require use of safety glasses and other appropriate safety equipment in the vicinity of use.

Hassay Savage Company, Inc., authorizes no other warranty by any other person or agent, nor recognizes as binding any warranty made by such person or agent on our company's behalf. We assume no further liability, except as stated herein.

Keyway Broaches Overview

HSS Keyway Broaches Are Available as Standard Items in Sizes 1/16" to 1-1/2" and 2mm to 36mm.



Keyway Broach

- Selecting a **STANDARD BROACH** from Hassay Savage is a simple process. Choose a tool, or set of tools that will produce the cut your finished part requires. Specify the EDP, size, and brief description when ordering to ensure proper delivery.

- All **STANDARD PRODUCTS** are maintained in finished goods inventory. We can ship your order the same day it is placed. Additional special widths and lengths are also available from semi-finished and finished stock, ground to your specifications with 1 week delivery.

Pressures listed in the charts are for maximum length of cut. If these lengths must be exceeded, a special Hassay Savage keyway broach can be ordered for specific length of cut and material.

Hassay Savage **VI Bushings** are available on **SPECIAL ORDER** in bore diameters of 3" - 6" for use with 7/8" - 1" keyway broaches.

- The specification charts on pages 14-18 describe the configurations, tolerances, cut lengths, and machine tonnage for each of the standard broaches we manufacture.
- Rake and relief angle geometries are CNC precision ground for efficient broaching in most mild steel materials for specified min/max LOC.
- In the event of thin pieces, pieces may be broached by stacking and nesting.
- **MODIFIED STANDARD KEYWAY BROACHES** are available within a 1 week period, for special widths and depths. This is an excellent delivery for the buyer looking for special applications for production or prototype.

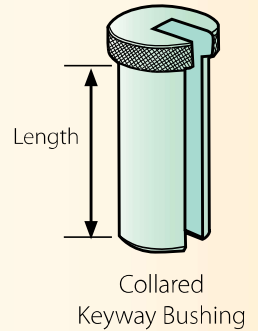

Collared Keyway Bushing

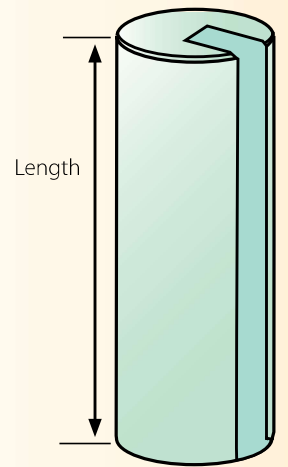

Plain Keyway Bushing



1" Keyway Broach

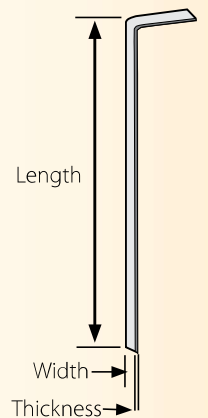
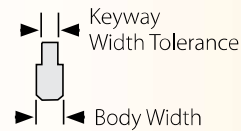
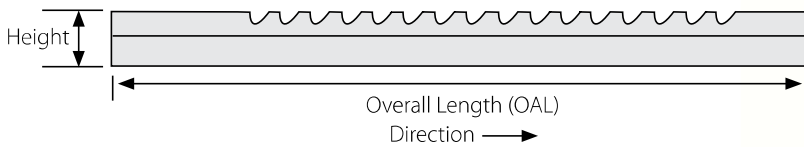

Keyway Broach Shim



Collared Keyway Bushing

Plain Keyway Bushing

Keyway Broach Shims

See these tools at work!



www.hassay-savage.com/resource-center/product-videos

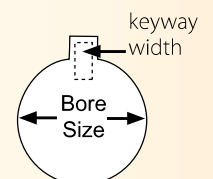

Keyway Broach Sets

American Inch Standard

Keyway Range 1/16" – 3/8" with Collared Bushings in Dura Case Sets

Precision Set 1

EDP No. 15315 **DURA CASE**

3 Broaches and 5 Collared Bushings
15 Keyway Combinations *Wt. 1 lbs.*

Keyway Sizes	Broach Style	Bushing Diameters (Hole Sizes)
1/16	I	1/4, 5/16, 3/8, 7/16, 1/2
3/32	I	
1/8	I	

Standard Set C-1

EDP No. 15318 **DURA CASE**

4 Broaches and 9 Collared Bushings
18 Keyway Combinations *Wt. 8 lbs.*

Keyway Sizes	Broach Style	Bushing Diameters (Hole Sizes)
1/8	II	1/2, 5/8, 3/4, 7/8
3/16	II	
1/4	III	1, 1-1/8, 1-1/4, 1-3/8, 1-1/2
3/8	III	

Standard Set C-1A

EDP No. 15319 **DURA CASE**

4 Broaches and 9 Collared Bushings
18 Keyway Combinations *Wt. 8 lbs.*

Keyway Sizes	Broach Style	Bushing Diameters (Hole Sizes)
1/8	II	9/16, 11/16, 13/16
3/16	II	
1/4	III	15/16, 1-1/16, 1-3/16, 1-5/16, 1-7/16, 1-9/16
3/8	III	

Standard Set C-2

EDP No. 15320 **DURA CASE**

3 Broaches and 9 Collared Bushings
15 Keyway Combinations *Wt. 8 lbs.*

Keyway Sizes	Broach Style	Bushing Diameters (Hole Sizes)
1/8	II	9/16, 11/16, 13/16
3/16	III	15/16, 1-1/16, 1-3/16,
1/4	III	1-5/16, 1-7/16, 1-9/16

Standard Set C-2A

EDP No. 15321 **DURA CASE**

3 Broaches and 9 Collared Bushings
14 Keyway Combinations *Wt. 8 lbs.*

Keyway Sizes	Broach Style	Bushing Diameters (Hole Sizes)
1/8	II	1/2, 5/8, 3/4, 7/8
3/16	III	1, 1-1/8, 1-1/4, 1-3/8, 1-1/2
1/4	III	

To select a standard broach from Hassay Savage, simply choose a tool, or set of tools that will produce the cut your finished part requires.

Specify the EDP, size, and brief description when ordering to ensure proper delivery.

The specification charts, on pages 14 & 15, describe the

- Dimensional Cuts,
- Configurations,
- Tolerances,
- Length of Cut, and
- Machine Tonnage for each standard broach we manufacture.

Standard Set C-10

EDP No. 15336 **DURA CASE**

4 Broaches and 18 Collared Bushings
36 Keyway Combinations *Wt. 13 lbs.*

Keyway Sizes	Broach Style	Bushing Diameters (Hole Sizes)
1/8	II	1/2, 9/16, 5/8, 11/16, 3/4, 13/16, 7/8
3/16	II	
1/4	III	15/16, 1, 1-1/16, 1-1/8, 1-3/16, 1-1/4, 1-5/16, 1-3/8, 1-7/16, 1-1/2, 1-9/16
3/8	III	

Standard Set C-10A

EDP No. 15330 **DURA CASE**

3 Broaches and 18 Collared Bushings
30 Keyway Combinations *Wt. 13 lbs.*

Keyway Sizes	Broach Style	Bushing Diameters (Hole Sizes)
1/8	II	1/2, 9/16, 5/8, 11/16, 3/4, 13/16, 7/8
3/16	III	
1/4	III	15/16, 1, 1-1/16, 1-1/8, 1-3/16, 1-1/4, 1-5/16, 1-3/8, 1-7/16, 1-1/2, 1-9/16

All broaches are CNC qualified!

**Hassay Savage
HSS Broach Sets come in
Durable Plastic Cases
(Dura Cases)
and include:**

- Broaches
- Bushings
- Shims
- Instructions

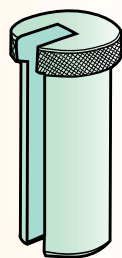

Collared
Keyway Bushing



Standard Set C-10 Dura Case

Heavy Duty Keyway Sets

American Inch Standard

Keyway Range 5/16" – 3/4" with Plain Bushings in Hardwood Cases

Standard Set 3-D

EDP No. 15024 **HARDWOOD**

4 Broaches and 8 Plain Bushings
32 Keyway Combinations *Wt. 50 lbs.*

Keyway Sizes	Broach Style	Bushing Diameters (Hole Sizes inches)
5/16	IV	1-1/2, 1-5/8, 1-3/4, 1-7/8 2, 2-1/8, 2-1/4, 2-1/2
3/8	IV	
7/16	IV	
1/2	IV	

Standard Set 3-DA

EDP No. 15124 **HARDWOOD**

4 Broaches and 8 Plain Bushings
32 Keyway Combinations *Wt. 50 lbs.*

Keyway Sizes	Broach Style	Bushing Diameters (Hole Sizes inches)
5/16	IV	1-7/16, 1-9/16, 1-11/16, 1-13/16, 1-15/16, 2-3/16, 2-7/16, 2-15/16
3/8	IV	
7/16	IV	
1/2	IV	

We are meeting the needs of today's industry. Hassay Savage broaches find use wherever precision broaching operations add to the quality and economical manufacture of identical parts.

The strength of our business has been built upon standard broaches available from stock and **SHIPPED ON THE SAME DAY THE ORDER IS PLACED.**

We are one of a very few broach manufacturers who sell standard tools from stock, which means we can satisfy our customers' needs immediately.

See these tools at work!



www.hassay-savage.com/resource-center/product-videos

Heavy Duty Set 4-E

EDP No. 15012 **HARDWOOD**

2 Broaches and 6 Plain Bushings
12 Keyway Combinations *Wt. 74 lbs.*

Keyway Sizes	Broach Style	Bushing Diameters (Hole Sizes)
5/8	V	2-3/8, 2-1/2, 2-5/8
3/4	V	2-3/4, 2-7/8, 3

Heavy Duty Set 4-F

EDP No. 15014 **HARDWOOD**

2 Broaches and 6 Plain Bushings
12 Keyway Combinations *Wt. 74 lbs.*

Keyway Sizes	Broach Style	Bushing Diameters (Hole Sizes)
5/8	V	2-5/16, 2-7/16, 2-9/16
3/4	V	2-11/16, 2-13/16, 2-15/16

Heavy Duty Set 5

EDP No. 15026 **HARDWOOD**

3 Broaches and 17 Plain Bushings
26 Keyway Combinations *Wt. 175 lbs.*

Keyway Sizes	Broach Style	Bushing Diameters (Hole Sizes)
1/2	IV	2, 2-1/16, 2-1/8, 2-3/16, 2-1/4, 2-5/16, 2-3/8, 2-7/16
5/8	V	2-1/2, 2-9/16, 2-5/8, 2-11/16, 2-3/4, 2-13/16,
3/4	V	2-7/8, 2-15/16, 3

All broaches are CNC qualified!



Standard Set 3-D Hardwood

**Hassay Savage
HSS Broach Sets in
Tongue and Grooved
Hardwood Cases
Include:**

- Broaches
- Bushings
- Shims
- Instructions

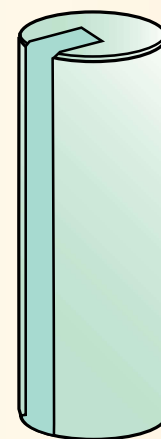

Plain
Keyway Bushing

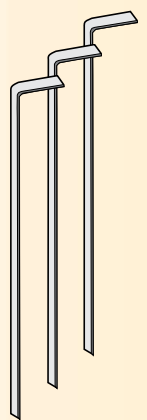

Keyway Broach
Shims

Metric Keyway Broach Sets

Standard Metric

Keyway Range 2mm - 18mm

Precision Set #10

EDP No. 15410 **DURA CASE**

2 Broaches and 5 Collared Bushings
10 Keyway Combinations *Wt. 1 lbs.*

Keyway Sizes	Broach Style	Metric Bushing Diameters (Hole Sizes mm)
2mm	I	6, 7, 8, 9, 10
3mm	I	

Metric Set #40

EDP No. 15440 **DURA CASE**

6 Broaches and 18 Collared Bushings
36 Keyway Combinations *Wt. 12 lbs.*

Keyway Sizes	Broach Style	Metric Bushing Diameters (Hole Sizes mm)
2mm	I	8, 10
3mm	I	
4mm	II	12, 14, 16, 18
5mm	II	
6mm	III	18, 19, 20, 22, 24, 25, 26, 28,
8mm	III	

Metric Set #18

EDP No. 15418 **DURA CASE**

4 Broaches and 9 Collared Bushings
18 Keyway Combinations *Wt. 7 lbs.*

Keyway Sizes	Broach Style	Metric Bushing Diameters (Hole Sizes mm)
4mm	II	12, 14, 16, 18
5mm	II	
6mm	III	20, 22, 24, 26, 28
8mm	III	

All standard products are maintained in finish good inventory. We can **SHIP YOUR ORDER THE SAME DAY IT IS PLACED!**

Additional special widths and lengths are also available from semi-finished stock ground to your specifications with quick delivery.

The specification charts, on pages 16 & 17, describe the

- Dimensional Cuts,
- Configurations,
- Tolerances,
- Length of Cut, and
- Machine Tonnage

for each standard broach we manufacture.

Hassay Savage HSS Broach Sets in Tongue and Grooved Hardwood Cases and Plastic Dura Cases include:

- Instructions
- Broaches
- Bushings
- Shims

Metric Set #24

EDP No. 15224 **HARDWOOD**

3 Broaches and 8 Plain Bushings
24 Keyway Combinations *Wt. 36 lbs.*

Keyway Sizes	Broach Style	Metric Bushing Diameters (Hole Sizes mm)
10mm	IV	34, 36, 38, 40, 42, 44, 46, 48
12mm	IV	
14mm	IV	

Metric Set #12

EDP No. 15212 **HARDWOOD**

2 Broaches and 6 Plain Bushings
12 Keyway Combinations *Wt. 70 lbs.*

Keyway Sizes	Broach Style	Metric Bushing Diameters (Hole Sizes mm)
16mm	V	54, 56, 58, 60, 62, 64
18mm	V	

Metric Set #30

EDP No. 15230 **HARDWOOD**

3 Broaches and 16 Plain Bushings
28 Keyway Combinations *Wt. 100 lbs.*

Keyway Sizes	Broach Style	Metric Bushing Diameters (Hole Sizes mm)
14mm	IV	44, 46, 48, 50
16mm	V	52, 54, 55, 56, 58, 60, 62, 64,
18mm	V	65, 66, 68, 70

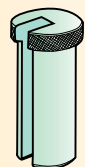

Collared Keyway Bushing



Metric Set #18



Metric Set #24

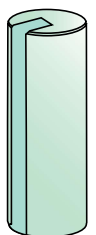

Plain Keyway Bushing

Metric Keyway Broach Sets

DIN Standard Metric

Keyway Range 2mm - 18mm

DIN is an abbreviation for the **German Institute for Standardization** (Deutsches Institut für Normung). There are currently around thirty thousand DIN Standards, covering nearly every field of technology.



DIN Standard Set #50

- **Hassay Savage Precision Quality Broaches**
- **M2 HSS Steel Keyway Broaches for long life**
- **Our most popular metric sizes all in one package**
- **Strong, light weight Dura Case goes anywhere**
- **Hardwood cases are Tongue and Grooved**



25mm Keyway Broach

DIN Standard for Keyway

Keyway Sizes	Bushing Diameters (mm)
2mm	6-8mm
3mm	8-10mm
4mm	10-12mm
5mm	12-17mm
6mm	17-22mm
8mm	22-30mm
10mm	30-38mm
12mm	38-44mm
14mm	44-50mm
16mm	50-58mm
18mm	58-65mm
20mm	65-75mm
22mm	75-85mm
24mm	85-95mm
25mm	85-95mm

DIN Standard Metric EDP No. 15410 **DURA CASE**

2 Broaches and 5 Collared Bushings
10 Keyway Combinations *Wt. 1 lbs.*

Keyway Sizes	Broach Style	Metric Bushing Diameters (Hole Sizes mm)
2mm	I	6, 7, 8, 9, 10
3mm	I	

DIN Standard Metric EDP No. 15418 **DURA CASE**

4 Broaches and 9 Collared Bushings
18 Keyway Combinations *Wt. 7 lbs.*

Keyway Sizes	Broach Style	Metric Bushing Diameters (Hole Sizes mm)
4mm	II	12, 14, 15, 16,
5mm	II	
6mm	III	18, 20, 22, 24, 25
8mm	III	



Collared Keyway Bushing

DIN Standard Metric EDP No. 15440 **DURA CASE**

6 Broaches and 13 Collared Bushings
26 Keyway Combinations *Wt. 12 lbs.*

Keyway Sizes	Broach Style	Metric Bushing Diameters (Hole Sizes mm)
2mm	I	8, 10
3mm	I	
4mm	II	12, 14, 15, 16
5mm	II	
6mm	III	18, 20, 22, 24, 25, 28, 30
8mm	III	

DIN Standard Metric EDP No. 15450 **DURA CASE**

2 Broaches and 5 Plain Bushings
10 Keyway Combinations *Wt. 13 lbs.*

Keyway Sizes	Broach Style	Metric Bushing Diameters (Hole Sizes mm)
10mm	IV	32, 35, 38, 40, 42
12mm	IV	

DIN Standard Metric EDP No. 15224 **HARDWOOD**

3 Broaches and 7 Plain Bushings
21 Keyway Combinations *Wt. 36 lbs.*

Keyway Sizes	Broach Style	Metric Bushing Diameters (Hole Sizes mm)
10mm	IV	32, 35, 38, 40, 42, 45, 50
12mm	IV	
14mm	IV	

DIN Standard Metric EDP No. 15212 **HARDWOOD**

2 Broaches and 5 Plain Bushings
10 Keyway Combinations *Wt. 70 lbs.*

Keyway Sizes	Broach Style	Metric Bushing Diameters (Hole Sizes mm)
16mm	V	52, 55, 58, 60, 65
18mm	V	



Plain Keyway Bushing

All broaches are CNC qualified!

Keyway Broaches American Inch Standard Sizes 1/16" to 3/8"

Bushings I, II, and III - Numbers 20116 - 20400 are **COLLARED Bushings**

Keyway broaches and bushings are clearly marked for bore size:

Any **I American Standard Broach** can be used with any **I American Standard Bushing**

Any **II American Standard Broach** can be used with any **II American Standard Bushing**

Any **III American Standard Broach** can be used with any **III American Standard Bushing**

In some cases American Standard CANNOT be used with Metric size Bushings and Broaches.

Please call with questions: 413-863-9371

I Broaches

Any **I Broach** can be used with any **I Bushing**

Broach	EDP No.	Width Tolerance	Body Width x OAL (in.)	No. of shims	Length of Cut Min.	Length of Cut Max.	Pressure Max.L/C (lbs.)
1/16-I	10104	.0625 - .0635	1/8 x 5-1/4	0	13/64	1-1/8	270
3/32-I	10106	.0937 - .0947	1/8 x 5-1/4	0	13/64	1-1/8	810
1/8-I	10108	.1252 - .1262	1/8 x 5-1/4	1	13/64	1-1/8	720

I Shims

Size	Thickness	Length & Width	EDP
1/8-I	.031	1-3/8 x 1/8	30108



Keyway Broach

I Bushings (Collared)

Diameter	Length	EDP
1/4	1-1/8	20116
5/16	1-1/8	20120
3/8	1-1/8	20124
7/16	1-1/8	20128
1/2	1-1/8	20132

II Broaches

Any **II Broach** can be used with any **II Bushing**

Broach	EDP No.	Width Tolerance	Body Width x OAL (in.)	No. of shims	Length of Cut Min.	Length of Cut Max.	Pressure Max.L/C (lbs.)
3/32-II	10206	.0937 - .0947	3/16 x 7	0	19/64	1-11/16	990
1/8-II	10208	.1252 - .1262	3/16 x 7	1	19/64	1-11/16	780
5/32-II	10210	.1564 - .1574	3/16 x 7	1	19/64	1-11/16	1,560
3/16-II	10212	.1877 - .1887	3/16 x 7	1	19/64	1-11/16	2,100

II Shims

Size	Thickness	Length & Width	EDP
1/8-II	.031	1-7/8 x 3/16	30208
5/32-II	.042	1-7/8 x 3/16	30210
3/16-II	.050	1-7/8 x 3/16	30212

Required shims are always supplied with each keyway broach. When ordering additional or replacement shims, specify EDP Number.

II Bushings (Collared)

Diameter	Length	EDP
1/2	1-11/16	20232
9/16	1-11/16	20236
5/8	1-11/16	20240
11/16	1-11/16	20244
3/4	1-11/16	20248
13/16	1-11/16	20252
7/8	1-11/16	20256

III Broaches

Any **III Broach** can be used with any **III Bushing**

Broach	EDP No.	Width Tolerance	Body Width x OAL (in.)	No. of shims	Length of Cut Min.	Length of Cut Max.	Pressure Max.L/C (lbs.)
3/16-III	10312	.1877 - .1887	3/8 x 11-7/8	1	13/32	2-1/2	1,440
1/4-III	10316	.2502 - .2512	3/8 x 11-7/8	1	13/32	2-1/2	2,580
5/16-III	10320	.3127 - .3137	3/8 x 11-7/8	1	13/32	2-1/2	4,200
3/8-III	10324	.3755 - .3765	3/8 x 11-7/8	2	13/32	2-1/2	3,600

III Shims

Size	Thickness	Length & Width	EDP
3/16-III	.050	2-7/8 x 3/8	30312
1/4-III	.062	2-7/8 x 3/8	30316
5/16-III	.078	2-7/8 x 3/8	30320
3/8-III	.062	2-7/8 x 3/8	30324

When ordering additional or replacement shims, specify EDP Number.

III Bushings (Collared)

Diameter	Length	EDP
3/4	2-1/2	20348
13/16	2-1/2	20352
7/8	2-1/2	20356
15/16	2-1/2	20360
1	2-1/2	20364
1-1/16	2-1/2	20368
1-1/8	2-1/2	20372
1-3/16	2-1/2	20376
1-1/4	2-1/2	20380
1-5/16	2-1/2	20384
1-3/8	2-1/2	20388
1-7/16	2-1/2	20392
1-1/2	2-1/2	20396
1-9/16	2-1/2	20400

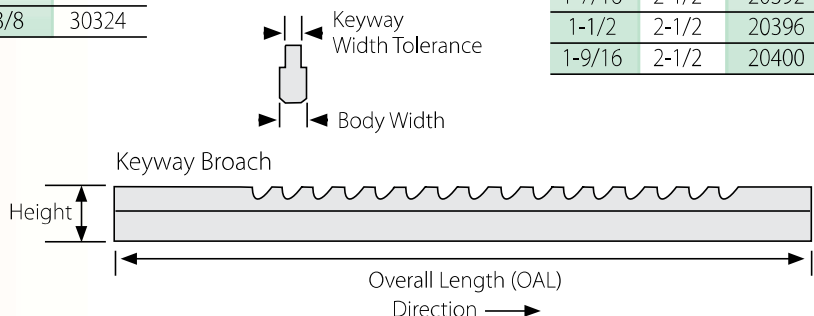
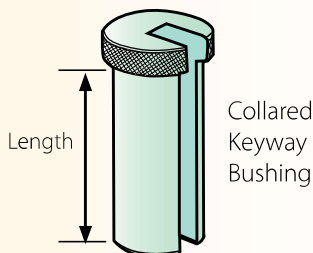
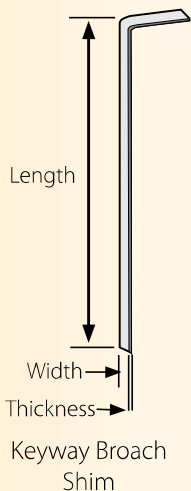

Keyway Broaches American Inch Standard Sizes 5/16" to 1-1/2"

Bushings IV and V - Numbers 21492 - 21732 are **PLAIN Bushings**

IV Broaches Any IV Broach can be used with any IV Bushing

Broach	EDP No.	Width Tolerance	Body Width x OAL (in.)	No. of shims	Length of Cut Min.	Length of Cut Max.	Pressure Max.L/C (lbs.)
5/16-IV	10420	.3127 - .3137	9/16 x 13-7/8	1	3/4	6	9,250
3/8-IV	10424	.3755 - .3765	9/16 x 13-7/8	2	3/4	6	8,000
7/16-IV	10428	.4380 - .4390	9/16 x 13-7/8	2	3/4	6	11,750
1/2-IV	10432	.5006 - .5016	9/16 x 13-7/8	3	3/4	6	11,000
9/16-IV	10436	.5630 - .5640	9/16 x 13-7/8	3	3/4	6	11,100

IV Shims

Size	Thickness	Length & Width	EDP
5/16-IV	.078	6-1/4 x 9/16	30420
3/8-IV	.062	6-1/4 x 9/16	30424
7/16-IV	.075	6-1/4 x 9/16	30428
1/2-IV	.062	6-1/4 x 9/16	30432
9/16-IV	.062	6-1/4 x 9/16	30436

Required shims are always supplied with each keyway broach.

When ordering additional or replacement shims, specify EDP Number.

IV Bushings (Plain)

Diameter	Length	EDP
1-7/16	4	21492
1-1/2	4	21496
1-9/16	4	21500
1-5/8	4	21504
1-11/16	4	21508
1-3/4	4	21512
1-13/16	5	21516
1-7/8	5	21520
1-15/16	5	21524
2	5	21528
2-1/16	5	21532
2-1/8	5	21536
2-3/16	5	21540
2-1/4	5	21544
2-5/16	5	21548
2-3/8	6	21552
2-7/16	6	21556
2-1/2	6	21560
2-9/16	6	21564
2-5/8	6	21568
2-11/16	6	21572
2-3/4	6	21576
2-13/16	6	21580
2-7/8	6	21584
2-15/16	6	21588
3	6	21592

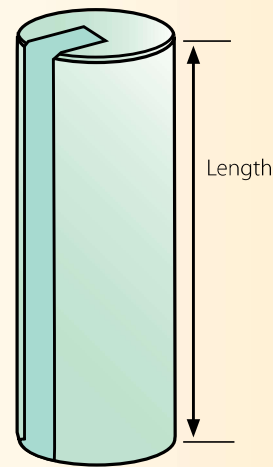

Plain Keyway Bushing

V Broaches Any V Broach can be used with any V Bushing

Broach	EDP No.	Width Tolerance	Body Width x OAL (in.)	No. of shims	Length of Cut Min.	Length of Cut Max.	Pressure Max.L/C (lbs.)
5/8-V	10540	.6260 - .6270	3/4 x 15-1/4	4	3/4	6	11,500
3/4-V	10548	.7515 - .7525	3/4 x 15-1/4	5	3/4	6	13,500

V Shims

Size	Thickness	Length & Width	EDP
5/8-V	.062	6-3/4 x 3/4	30540
3/4-V	.062	6-3/4 x 3/4	30548

V Bushings (Plain)

Diameter	Length	EDP
2-5/16	6	21688
2-3/8	6	21692
2-7/16	6	21696
2-1/2	6	21700
2-9/16	6	21704
2-5/8	6	21708
2-11/16	6	21712
2-3/4	6	21716
2-13/16	6	21720
2-7/8	6	21724
2-15/16	6	21728
3	6	21732

Keyway broaches and bushings are clearly marked for bore size:

Any **IV Broach** can be used with any **IV Bushing**

Any **V Broach** can be used with any **V Bushing**

VI Bushings can be Special Ordered in diameter sizes 3" -6"

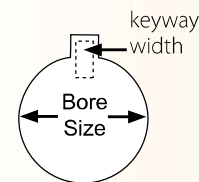

Keyway Shims correspond to broach size, not to bushing size.

Collared Keyway Bushing



Plain Keyway Bushing



Keyway Broach Shims

VI Broaches

Broach	EDP No.	Width Tolerance	Body Width x OAL (in.)	No. of shims	Length of Cut Min.	Length of Cut Max.	Pressure Max.L/C (lbs.)
7/8-VI	10656	.8765 - .8775	1 x 19-1/4	6	3/4	6	11,000
1-VI	10664	1.0015 - 1.0025	1 x 19-1/4	7	3/4	6	14,000

Standard Oversize Keyways

Size	EDP No.	Width Tolerance	Body Width x OAL (in.)	No. of shims	Length of Cut Min.	Length of Cut Max.	Pressure Max.L/C (lbs.)
1-1/8	10666	1.1260 - 1.1270	1-1/8 x 23	8	3/4	6	15,750
1-1/4	10668	1.2510 - 1.2520	1-1/4 x 23	9	3/4	6	14,500
1-3/8	10670	1.3760 - 1.3770	1-3/8 x 23	10	3/4	6	19,250
1-1/2	10672	1.5020 - 1.5030	1-1/2 x 23	11	3/4	6	21,000

VI Shims

Size	Thickness	Length & Width	EDP
7/8-VI	.062	6-3/4 x 1	30656
1-VI	.062	6-3/4 x 1	30664

Standard Oversize Keyways

Size	Thickness	Length & Width	EDP
1-1/8	.062	7 x 1-1/8	30740
1-1/4	.062	7 x 1-1/4	30750
1-3/8	.062	7 x 1-1/4	30760
1-1/2	.062	7 x 1-1/4	30770

Hassay Savage plain **VI Bushings** are available on **SPECIAL ORDER** in diameter sizes 3" -6"

Metric Keyway Broaches

Standard Sizes 2mm-8mm

Bushings mm I, mm II, and mm III - Numbers 22106-22336 are **COLLARED Bushings** **ISO JS 9 Tolerance**

mm I Broaches *Any mm I Broach can be used with any mm I Bushing*

Broach	EDP No.	JS 9 Width Tolerance	Standard Millimeter Keys	Body Width x OAL (in.)	No. of shims	Length of Cut		Pressure Max.L/C (lbs.)
						Min.	Max.	
2mm-I	11102	.0782 - .0792	2mm x 2mm	1/8 x 5-1/4	0	13/64	1-1/8	510
3mm-I	11103	.1176 - .1186	3mm x 3mm	1/8 x 5-1/4	1	13/64	1-1/8	720

mm I Bushings

Size	Dim. In.	Length	EDP No.
6mm-I	.2362	1-1/8	22106
7mm-I	.2756	1-1/8	22107
8mm-I	.3150	1-1/8	22108
9mm-I	.3543	1-1/8	22109
10mm-I	.3937	1-1/8	22110

mm I Shims

Size	Thickness	Length & Width	EDP
3mm-I	.031	1-3/8 x 1/8	31103

Shims correspond to metric broach size, not to bushing size.

mm II Broaches *Any mm II Broach can be used with any mm II Bushing*

Broach	EDP No.	JS 9 Width Tolerance	Standard Millimeter Keys	Body Width x OAL (in.)	No. of shims	Length of Cut		Pressure Max.L/C (lbs.)
						Min.	Max.	
4mm-II	11204	.1569 - .1581	4mm x 4mm	1/4 x 7	1	19/64	1-11/16	1,140
5mm-II	11205	.1963 - .1975	5mm x 5mm	1/4 x 7	1	19/64	1-11/16	2,040

mm II Bushings

Size	Dim. In.	Length	EDP No.
11mm-II	.4331	1-11/16	22211
12mm-II	.4724	1-11/16	22212
13mm-II	.5118	1-11/16	22213
14mm-II	.5512	1-11/16	22214
15mm-II	.5905	1-11/16	22215
16mm-II	.6299	1-11/16	22216
17mm-II	.6693	1-11/16	22217
18mm-II	.7087	1-11/16	22218
19mm-II	.7480	1-11/16	22219

mm II Shims

Size	Thickness	Length & Width	EDP
4mm-II	.038	1-7/8 x 1/4	31204
5mm-II	.050	1-7/8 x 1/4	31205

Required shims are always supplied with each keyway broach.

When ordering additional or replacement shims, specify EDP Number.

mm III Broaches *Any mm III Broach can be used with any mm III Bushing*

Broach	EDP No.	JS 9 Width Tolerance	Standard Millimeter Keys	Body Width x OAL (in.)	No. of shims	Length of Cut		Pressure Max.L/C (lbs.)
						Min.	Max.	
5mm-III	11305	.1963 - .1975	5mm x 5mm	3/8 x 11-7/8	1	13/32	2-1/2	1,680
6mm-III	11306	.2356 - .2368	6mm x 6mm	3/8 x 11-7/8	1	13/32	2-1/2	1,890
7mm-III	11307	.2749 - .2763	7mm x 7mm	3/8 x 11-7/8	1	13/32	2-1/2	2,985
8mm-III	11308	.3143 - .3157	8mm x 8mm	3/8 x 11-7/8	1	13/32	2-1/2	3,995

mm III Bushings

Size	Dim. In.	Length	EDP No.
17mm-III	.6693	2-1/2	22317
18mm-III	.7087	2-1/2	22318
19mm-III	.7480	2-1/2	22319
20mm-III	.7874	2-1/2	22320
22mm-III	.8661	2-1/2	22322
24mm-III	.9449	2-1/2	22324
25mm-III	.9842	2-1/2	22325
26mm-III	1.0236	2-1/2	22326
27mm-III	1.0630	2-1/2	22327
28mm-III	1.1024	2-1/2	22328
30mm-III	1.1811	2-1/2	22330
32mm-III	1.2598	2-1/2	22332
34mm-III	1.3386	2-1/2	22334
35mm-III	1.3779	2-1/2	22335
36mm-III	1.4173	2-1/2	22336

mm III Shims

Size	Thickness	Length & Width	EDP
5mm-III	.047	2-7/8 x 3/8	31305
6mm-III	.062	2-7/8 x 3/8	31306
7mm-III	.062	2-7/8 x 3/8	31307
8mm-III	.078	2-7/8 x 3/8	31308

Keyway Metric Broaches and Metric Bushings are clearly marked for bore size:

Any **mm I Broach** can be used with any **mm I Bushing**,
 Any **mm II Broach** can be used with any **mm II Bushing**,
 Any **mm III Broach** can be used with any **mm III Bushing**,

In some cases American Standard CANNOT be used with Metric size Bushings and Broaches. Please call with questions: 413-863-9371

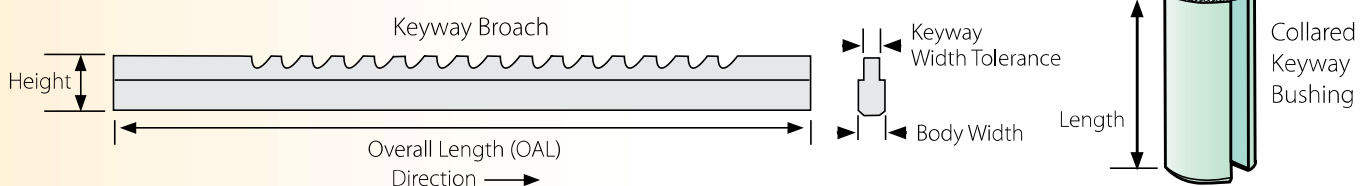

Metric Keyway Broaches

Standard Sizes 10mm-36mm

Bushings mm IV and mm V - Numbers 22432-22572 are **PLAIN Bushings**

ISO JS 9 Tolerance



mm IV Broaches

Any mm IV Broach can be used with any mm IV Bushing

Broach	EDP No.	JS 9 Width Tolerance	Standard Millimeter Keys	Body Width x OAL (in.)	No. of shims	Length of Cut Min.	Length of Cut Max.	Pressure Max.L/C (lbs.)
10mm-IV	11410	.3930 - .3944	10mm x 8mm	9/16 x 13-7/8	2	3/4	6	8,100
12mm-IV	11412	.4716 - .4732	12mm x 8mm	9/16 x 13-7/8	2	3/4	6	10,550
14mm-IV	11414	.5504 - .5520	14mm x 9mm	9/16 x 13-7/8	2	3/4	6	11,090

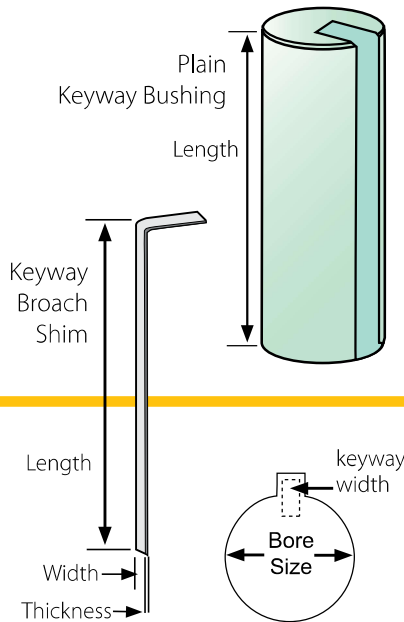

mm IV Shims

Size	Thickness	Length & Width	EDP
10mm-IV	.056	6-1/4 x 9/16	31410
12mm-IV	.056	6-1/4 x 9/16	31412
14mm-IV	.062	6-1/4 x 9/16	31414

Shims correspond to metric broach size, not to bushing size.

mm IV Bushings

Size	Dim. In.	Length	EDP No.
32mm-IV	1.2598	4	22432
34mm-IV	1.3386	4	22434
35mm-IV	1.3779	4	22435
36mm-IV	1.4173	4	22436
38mm-IV	1.4961	4	22438
40mm-IV	1.5748	4	22440
42mm-IV	1.6535	4	22442
44mm-IV	1.7323	4	22444
45mm-IV	1.7716	5	22445
46mm-IV	1.8110	5	22446
48mm-IV	1.8898	5	22448
50mm-IV	1.9685	5	22450
52mm-IV	2.0472	5	22452
54mm-IV	2.1260	5	22454
55mm-IV	2.1653	5	22455
56mm-IV	2.2047	5	22456

mm V Shims

Size	Thickness	Length & Width	EDP
16mm-V	.062	6-3/4 x 3/4	31516
18mm-V	.062	6-3/4 x 3/4	31518

mm V Bushings

Size	Dim. In.	Length	EDP No.
52mm-V	2.0472	5	22552
54mm-V	2.126	5	22554
55mm-V	2.1653	5	22555
56mm-V	2.2047	5	22556
58mm-V	2.2835	5	22558
60mm-V	2.3622	6	22560
62mm-V	2.4409	6	22562
64mm-V	2.5197	6	22564
65mm-V	2.5590	6	22565
66mm-V	2.5984	6	22566
68mm-V	2.6772	6	22568
70mm-V	2.7559	6	22570
72mm-V	2.8346	6	22572

mm V Broaches

Any mm V Broach can be used with any mm V Bushing

Broach	EDP No.	JS 9 Width Tolerance	Standard Millimeter Keys	Body Width x OAL (in.)	No. of shims	Length of Cut Min.	Length of Cut Max.	Pressure Max.L/C (lbs.)
16mm-V	11516	.6291 - .6307	16mm x 10mm	3/4 x 15-1/4	3	3/4	6	11,375
18mm-V	11518	.7079 - .7095	18mm x 11mm	3/4 x 15-1/4	3	3/4	6	12,000

Required shims are always supplied with each keyway broach.

When ordering additional or replacement shims, specify EDP Number.

mm VI Broaches

Any mm VI Broach can be used with any mm VI Bushing

Broach	EDP No.	JS 9 Width Tolerance	Standard Millimeter Keys	Body Width x OAL (in.)	No. of shims	Length of Cut Min.	Length of Cut Max.	Pressure Max.L/C (lbs.)
20mm-VI	11620	.7864 - .7884	20mm x 12mm	1 x 19-1/4	3	3/4	6	11,000
22mm-VI	11622	.8651 - .8671	22mm x 14mm	1 x 19-1/4	4	3/4	6	11,200
24mm-VI	11624	.9439 - .9459	24mm x 14mm	1 x 19-1/4	4	3/4	6	13,075
25mm-VI	11625	.9833 - .9853	25mm x 14mm	1 x 19-1/4	4	3/4	6	13,275

Standard Oversize Keyways

Size	EDP No.	JS 9 Width Tolerance	Standard Millimeter Keys	Body Width x OAL (in.)	No. of shims	Length of Cut Min.	Length of Cut Max.	Pressure Max.L/C (lbs.)
28mm	11628	1.1034 - 1.1014	28mm x 14mm	1-1/8 x 23	4	3/4	6	14,700
30mm	11630	1.1821 - 1.1801	30mm x 14mm	1-1/4 x 23	5	3/4	6	15,700
32mm	11632	1.2610 - 1.2586	32mm x 14mm	1-1/4 x 23	5	3/4	6'	16,790
36mm	11636	1.4185 - 1.4161	36mm x 14mm	1-7/16 x 23	5	3/4	6	18,590

mm VI Shims

Size	Thickness	Length & Width	EDP
20mm-VI	.062	6-3/4 x 1	31620
22mm-VI	.062	6-3/4 x 1	31622
24mm-VI	.062	6-3/4 x 1	31624
25mm-VI	.062	6-3/4 x 1	31625

Standard Oversize Keyways

Size	Thickness	Length & Width	EDP
28mm	.062	7 x 1	31628
30mm	.062	7 x 1	31630
32mm	.062	7 x 1-1/4	31632
36mm	.062	7 x 1-1/4	31636

Hassay Savage Metric **VI Bushings** are available on **SPECIAL ORDER** in diameter sizes 75mm - 150mm

Metric Keyway Broaches

Standard Sizes
ISO P9 Tolerance

Optional Metric Keyway Broaches ISO P9

	Broach	EDP No.	P9 Width Tolerance	Standard Millimeter Keys	Body Width x OAL (in.)	No. of shims	Length of Cut		Pressure Max.L/C (lbs.)
							Min.	Max.	
I	2mm-I	11102P9	.0775 - .0785	2mm x 2mm	1/8 x 5-1/4	0	13/64	1-1/8	510
	3mm-I	11103P9	.1169 - .1179	3mm x 3mm	1/8 x 5-1/4	1	13/64	1-1/8	720
II	4mm-II	11204P9	.1559 - .1570	4mm x 4mm	1/4 x 7	1	19/64	1-11/16	1,140
	5mm-II	11205P9	.1953 - .1964	5mm x 5mm	1/4 x 7	1	19/64	1-11/16	2,040
III	5mm-III	11305P9	.1963 - .1973	5mm x 5mm	3/8 x 11-7/8	1	13/32	2-1/2	1,680
	6mm-III	11306P9	.2342 - .2357	6mm x 6mm	3/8 x 11-7/8	1	13/32	2-1/2	1,890
	7mm-III	11307P9	.2736 - .2750	7mm x 7mm	3/8 x 11-7/8	1	13/32	2-1/2	2,985
	8mm-III	11308P9	.3130 - .3144	8mm x 8mm	3/8 x 11-7/8	1	13/32	2-1/2	3,995
IV	10mm-IV	11410P9	.3917 - .3931	10mm x 8mm	9/16 x 13-7/8	2	3/4	6	8,100
	12mm-IV	11412P9	.4700 - .4717	12mm x 8mm	9/16 x 13-7/8	2	3/4	6	10,550
	14mm-IV	11414P9	.5488 - .5505	14mm x 9mm	9/16 x 13-7/8	2	3/4	6	11,090
V	16mm-V	11516P9	.6275 - .6292	16mm x 10mm	3/4 x 15-1/4	3	3/4	6	11,375
	18mm-V	11518P9	.7063 - .7080	18mm x 11mm	3/4 x 15-1/4	3	3/4	6	12,000
VI	20mm-VI	11620P9	.7845 - .7865	20mm x 12mm	1 x 19-1/4	3	3/4	6	11,000
	22mm-VI	11622P9	.8632 - .8652	22mm x 14mm	1 x 19-1/4	4	3/4	6	11,200
	24mm-VI	11624P9	.9420 - .9440	24mm x 14mm	1 x 19-1/4	4	3/4	6	13,075
	25mm-VI	11625P9	.9814 - .9834	25mm x 14mm	1 x 19-1/4	4	3/4	6	13,275

- Standard metric tolerances are to ISO JS 9 and P9.
- Preferred metric limits fits -ANSI B4.2-1978 (American National Standards Institute)
- Optional metric tolerances are available to ISO P9. The ISO P9 option listed on this page utilizes the same bushings and shims as the Standard JS 9 metric broaches listed on the previous page.
- Bushings mm I, mm II, and mm III are COLLARED Bushings. Bushings mm IV and mm V are PLAIN.
- Hassay Savage mm VI Bushings are available on SPECIAL ORDER in diameter sizes 75mm-150mm

One Pass Keyway Broaches

All One Pass Keyways Are Used With STANDARD BUSHINGS

One Pass Keyway Broaches American Standard

	Broach	EDP No.	Width Tolerance	Body Width x OAL (in.)	Length of Cut		Pressure Max.L/C (lbs.)
					Min.	Max.	
II	1/8-II	10208-COP**	.1252 - .1262	3/16 x 10-3/4	1/4	1-1/2	780
	5/32-II	10210-COP**	.1564 - .1574	3/16 x 10-3/4	1/4	1-1/2	1,370
	3/16-II	10212-OP*	.1877 - .1887	3/16 x 10-3/4	1/4	1-1/2	1,930
III	3/16-III	10312-COP**	.1877 - .1887	3/8 x 18-1/2	5/16	1-11/16	1,090
	1/4-III	10316-COP**	.2502 - .2512	3/8 x 18-1/2	5/16	1-11/16	1,840
	5/16-III	10320-COP**	.3127 - .3137	3/8 x 18-1/2	5/16	1-11/16	2,860
	3/8-III	10324-OP*	.3755 - .3765	3/8 x 18-1/2	5/16	1-11/16	4,030

OP* designates one-pass, no chamfer COP** designates chamfer one-pass



Collared Keyway Bushing

One Pass Metric Keyway Broaches to ISO H9 Tolerance

	Broach	EDP No.	Width Tolerance	Standard Millimeter Keys	Body Width x OAL (in.)	Length of Cut		Pressure Max.L/C (lbs.)
						Min.	Max.	
I	3mm-I	11103-OP*	.1185 - .1190	3mm x 3mm	1/8 x 8-1/2	1/4	1-1/8	780
	4mm-II	11204-COP**	.1581 - .1585	4mm x 4mm	1/4 x 10-3/4	1/4	1-1/2	1,370
II	5mm-II	11205-COP**	.1975 - .1979	5mm x 5mm	1/4 x 10-3/4	1/4	1-1/2	1,930
	6mm-III	11306-COP**	.2372 - .2376	6mm x 6mm	3/8 x 18-1/2	5/16	1-11/16	1,090
III	8mm-III	11308-COP**	.3159 - .3163	8mm x 7mm	3/8 x 18-1/2	5/16	1-11/16	1,840

OP* designates one-pass, no chamfer COP** designates chamfer one-pass

CNC Single Point Keyway Broaching

Keyway Size Ranges 1/8"-1/2" and 4mm-12mm

Broaching keyways on CNC machines today is as common as turning a part.

- Eliminate part handling and improve your control
- Short effective nibbling broaches that take the place of longer tools
- Quick set up on CNC machines

Save Time and Money with blind hole and through hole CNC keyway broaching with standard tools that are **off the shelf**.

- Single point nibbling cutters that are designed with two separate cutting surfaces at 180° apart.
- The one piece construction is created on a high speed tooling blank that has common size round shank with 4 ground timing flats to align the keyway for timing to the part it is broaching.
- These tools will offer long tool life, and can be easily sharpened many times for extended tool life.
- Ideally designed for either CNC lathe or CNC vertical machining centers.

For CNC lathe: mount tool directly into the turret on centerline while a setscrew-locking holder will lock into place and position.

For CNC vertical machining center: a collet will hold the tool shank and provide timing orientation.

With the spindle locked, the broach can be brought in line with pre-prepared bore diameter and chamfer lead of the part to start broaching the keyway at a speed of 10" – 30" in/min and an in-feed of .003"-.005" depth per pass, using a flood coolant for lubrication during the cut. Once the initial process is achieved, speeds can be increased to 50 - 80 IPM. The in-feeding cycle is repeated until the desired depth of the keyway is achieved. Chips can be removed from the bottom of the hole in a couple of ways:

In a **blind hole bore**, remove the chips by either:

- prior trepanning the bottom of the keyway area and allow chips to fall away.
- or pre-drill a hole from the outside to the inside of the part at the bottom of the keyway location.

With a **through hole**, you can broach right through, but do not disengage with the part, and simply de-burr the keyway upon completion.

The ADVANTAGES:

- Complete the part on one machine
- Only way to keyway a blind hole
 - Cut down on set-up time
 - Improve your process
- Become more flexible with machining
 - Manage small lot production
- Use cost effective standard tooling
 - No bushing guide required
- No hydraulic press or pull required

THINGS THAT YOU SHOULD KNOW:

- Standard tooling will come with common shank diameters.
- Keyway size and length or depth of cut will determine the shank size.
- Strength and rigidity in the set-up will give you longer tool life.
- Keyway production will achieve excellent finishes and better accuracy.
- Specials are available with expedited delivery.

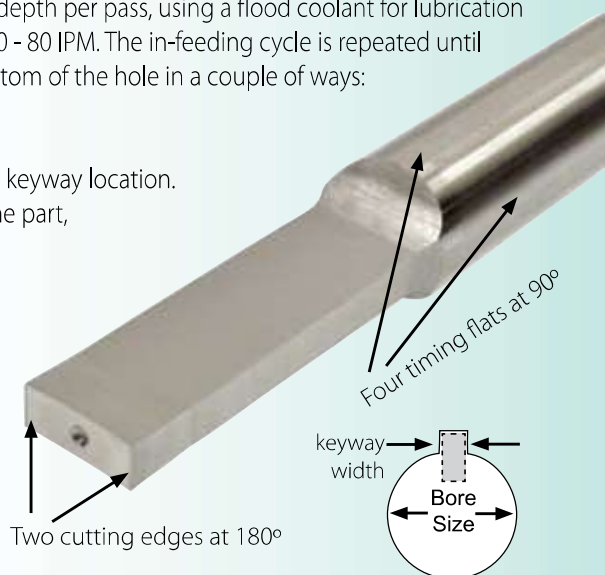

CNC Single Point Keyway Inch Shank

Keyway Size	EDP No.	Tolerance (inches)	Shank Diameter	Overall Length	Max. LOC	Min. Bore Size
1/8	69008	0.127	5/8	3.75	1.5	7/16
4mm	69004	0.159	5/8	3.75	1.5	9/16
3/16	69012	0.189	5/8	3.75	1.5	9/16
5mm	69005	0.198	5/8	3.75	1.5	5/8
6mm	69106	0.238	3/4	4.50	2	11/16
1/4	69116	0.252	3/4	4.50	2	11/16
5/16	69120	0.314	3/4	4.50	2	3/4
8mm	69108	0.317	3/4	4.50	2	3/4
3/8	69224	0.377	1	4.50	2	1
10mm	69210	0.396	1	4.50	2	1
12mm	69212	0.474	1	4.50	2	1
1/2	69232	0.502	1	4.50	2	1

CNC Single Point Keyway Metric Shank

Keyway Size	EDP No.	Tolerance (inches)	Shank Diameter	Overall Length	Max. LOC	Min. Bore Size
1/8	69308	0.127	16 mm	3.75	1.5	11mm
4mm	69304	0.159	16 mm	3.75	1.5	14mm
3/16	69312	0.189	16 mm	3.75	1.5	14mm
5mm	69305	0.198	16 mm	3.75	1.5	16mm
6mm	69406	0.238	20 mm	4.50	2	17mm
1/4	69416	0.252	20 mm	4.50	2	17mm
5/16	69420	0.314	20 mm	4.50	2	17mm
8mm	69408	0.317	20 mm	4.50	2	17mm
3/8	69524	0.377	25 mm	4.50	2	25mm
10mm	69510	0.396	25 mm	4.50	2	25mm
12mm	69512	0.474	25 mm	4.50	2	25mm
1/2	69532	0.502	25 mm	4.50	2	25mm

Hexagonal Rotary Punch Broaches M-2

Material: M-2 HSS For Cutting Mild Steel Applications

Rotary/Punch Broaches:

- Use in a variety of machines
- Cut polygons in blind holes
- Any type of CNC or manual turning, milling, drilling or screw machine.



Punching Versus Rotary Broaching:

Many applications can be achieved without the rotary broach holder.

For the purpose of merely punching a polygon into an existing pilot hole, these broaches have successfully been used with universal machining methods.

Hexagonal Rotary/Punch Broaches

8mm - .315 Shank Inch

EDP #	Hex Size	Across Flats +.001 / -.000	Max. Depth of Cut	Overall Length*
66002	.050	0.050	5/64	1-1/4
66004	1/16	0.063	3/32	1-1/4
66005	5/64	0.079	7/64	1-1/4
66006	3/32	0.095	9/64	1-1/4
66007	7/64	0.111	5/32	1-1/4
66008	1/8	0.127	3/16	1-1/4
66009	9/64	0.143	7/32	1-1/4
66010	5/32	0.158	1/4	1-1/4
66012	3/16	0.190	9/32	1-1/4
66014	7/32	0.221	9/32	1-1/4
66016	1/4	0.252	3/8	1-1/4
66018	9/32	0.284	3/8	1-1/4
66020	5/16	0.315	3/8	1-1/4
66022	11/32	0.346	7/16	1-1/4
66024	3/8	0.378	1/2	1-1/4
66026	13/32	0.410	1/2	1-1/4
66028	7/16	0.441	1/2	1-1/4
66030	15/32	0.472	1/2	1-1/4
66032	1/2	0.504	1/2	1-1/4

Hexagonal Rotary/Punch Broaches

8mm - .315 Shank Metric

EDP #	Hex Size	Across Flats +.001 / -.000	Max. Depth of Cut	Overall Length*
662013	1.3 mm	0.050	3/32	1-1/4
662015	1.5 mm	0.061	3/32	1-1/4
66202	2 mm	0.081	7/64	1-1/4
662025	2.5 mm	0.101	5/32	1-1/4
66203	3 mm	0.120	3/16	1-1/4
662035	3.5 mm	0.139	3/16	1-1/4
66204	4 mm	0.160	1/4	1-1/4
662045	4.5 mm	0.179	1/4	1-1/4
66205	5 mm	0.199	5/16	1-1/4
66206	6 mm	0.238	3/8	1-1/4
66207	7 mm	0.278	3/8	1-1/4
66208	8 mm	0.319	3/8	1-1/4
66209	9 mm	0.358	3/8	1-1/4
66210	10 mm	0.398	1/2	1-1/4
66211	11 mm	0.437	1/2	1-1/4
66212	12 mm	0.476	1/2	1-1/4

Hexagonal Rotary/Punch Broaches

3/4" - .750 Shank Inch

EDP #	Hex Size	Across Flats +.001 / -.000	Max. Depth of Cut	Overall Length*
66524	3/8	0.379	1/2	2-3/4
66528	7/16	0.442	1/2	2-3/4
66532	1/2	0.505	5/8	2-3/4
66536	9/16	0.567	3/4	2-3/4
66540	5/8	0.631	3/4	2-3/4
66548	3/4	0.754	7/8	2-3/4
66556	7/8	0.883	7/8	2-3/4
66564	1	1.014	7/8	2-3/4

Hexagonal Rotary/Punch Broaches

1/2" - .500 Shank Inch

EDP #	Hex Size	Across Flats +.001 / -.000	Max. Depth of Cut	Overall Length*
66106	3/32	0.095	9/64	1-3/4
66107	7/64	0.111	5/32	1-3/4
66108	1/8	0.127	3/16	1-3/4
66109	9/64	0.143	7/32	1-3/4
66110	5/32	0.158	1/4	1-3/4
66112	3/16	0.190	9/32	1-3/4
66114	7/32	0.221	9/32	1-3/4
66116	1/4	0.252	3/8	1-3/4
66118	9/32	0.284	7/16	1-3/4
66120	5/16	0.315	1/2	1-3/4
66122	11/32	0.346	9/16	1-3/4
66124	3/8	0.378	9/16	1-3/4
66126	13/32	0.410	5/8	1-3/4
66128	7/16	0.441	5/8	1-3/4
66130	15/32	0.472	5/8	1-3/4
66132	1/2	0.504	5/8	1-3/4
66136	9/16	0.567	5/8	1-3/4
66140	5/8	0.630	7/8	1-3/4
66144	11/16	0.693	7/8	1-3/4
66148	3/4	0.755	7/8	1-3/4

Hexagonal Rotary/Punch Broaches

1/2" - .500 Shank Metric

EDP #	Hex Size	Across Flats +.001 / -.000	Max. Depth of Cut	Overall Length*
66302	2mm	0.081	5/32	1-3/4
663025	2.5mm	0.101	5/32	1-3/4
66303	3mm	0.120	3/16	1-3/4
66304	4mm	0.160	1/4	1-3/4
66305	5mm	0.199	5/16	1-3/4
66306	6mm	0.239	3/8	1-3/4
66307	7mm	0.278	1/2	1-3/4
66308	8mm	0.320	1/2	1-3/4
66309	9mm	0.358	1/2	1-3/4
66310	10mm	0.398	9/16	1-3/4
66311	11mm	0.437	9/16	1-3/4
66312	12mm	0.476	5/8	1-3/4
66313	13mm	0.516	5/8	1-3/4
66314	14mm	0.556	5/8	1-3/4
66315	15mm	0.597	5/8	1-3/4
66316	16mm	0.636	5/8	1-3/4
66317	17mm	0.674	7/8	1-3/4
66318	18mm	0.714	7/8	1-3/4
66319	19mm	0.754	7/8	1-3/4

The practical forming length of rotary punch broaching is usually up to 1-1/2 times the size of the broach (measured across flats).

*Overall Tool Length Tolerances +/- .015

Hexagonal Rotary Punch Broaches M-42

Material: M-42 HSS With **8% COBALT CONTENT** For More Difficult To Machine Alloys



Broach Tool Material

These broaches are manufactured from **M-42 Cobalt High Speed Steel**. This material provides edge toughness for standard operations, and resists heat to effect better tool life in machining most metals.

For broaching materials such as ductile iron, tool steel, stainless steels, titanium alloys, or nickel-cobalt alloys, this superior grade of high speed steel with **8% COBALT CONTENT** provides significantly longer tool life with these more difficult to machine alloys.

What Is The Difference Between Rotary, Swiss, Punch & Index?

Rotary:

The tool shape is cut into the customer's part with spindle turning when using a rotary holder system.

Broaching Holder:

Serves two functions

- Holds the broach tool in a free spinning bearing
- Places the broach tool at a 1° angle relative to the centerline of the workpiece.

There are two types of commonly used holders:

Adjustable Rotary Broach Holder

Non-Adjustable Rotary Broach Holder

Swiss Style:

The tool shape is cut into the customer's part with the spindle turning when using a rotary holder system. This is typical when used on a horizontal machining center.

Punch:

The shape is cut into the customer's part with spindle locked in a stationary position, and the broach is then punched into the customer's part without a rotary holder.

Index:

A broaching process that involves a stationary spindle and a partial form of the shape that is to be generated. Once hole preparation is completed, the tool form is generated on a CNC machine by making imprints of the tool to the proper depth while the part is indexed properly to create the full form desired. **See page 27 for more details on Index Broaching.**

For more information see our Basic Broaching Learning Modules at www.hassay-savage.com/resource-center



Hexagonal Rotary/Punch Broaches

8mm - .315 Shank

Metric

EDP #	Hex Size	Across Flats +.001 / -.000	Max. Depth of Cut	Overall Length*
66202-M42	2mm	0.081	7/64	1-1/4
662025-M42	2.5mm	0.101	5/32	1-1/4
66203-M42	3mm	0.120	3/16	1-1/4
662035-M42	3.5mm	0.139	3/16	1-1/4
66204-M42	4mm	0.160	1/4	1-1/4
662045-M42	4.5mm	0.179	1/4	1-1/4

Hexagonal Rotary/Punch Broaches

8mm - .315 Shank

Inch

EDP #	Hex Size	Across Flats +.001 / -.000	Max. Depth of Cut	Overall Length*
66004-M42	1/16	0.063	3/32	1-1/4
66005-M42	5/64	0.079	7/64	1-1/4
66006-M42	3/32	0.095	9/64	1-1/4
66007-M42	7/64	0.111	5/32	1-1/4
66008-M42	1/8	0.127	3/16	1-1/4
66009-M42	9/64	0.143	7/32	1-1/4
66010-M42	5/32	0.158	1/4	1-1/4
66012-M42	3/16	0.190	9/32	1-1/4
66014-M42	7/32	0.221	11/32	1-1/4
66016-M42	1/4	0.252	3/8	1-1/4
66018-M42	9/32	0.284	3/8	1-1/4
66020-M42	5/16	0.315	3/8	1-1/4
66022-M42	11/32	0.346	7/16	1-1/4
66024-M42	3/8	0.378	1/2	1-1/4

Hexagonal Rotary/Punch Broaches

1/2 - .500 Shank

Inch

EDP #	Hex Size	Across Flats +.001 / -.000	Max. Depth of Cut	Overall Length*
66106-M42	3/32	0.095	9/64	1-3/4
66107-M42	7/64	0.111	5/32	1-3/4
66108-M42	1/8	0.127	3/16	1-3/4
66109-M42	9/64	0.143	7/32	1-3/4
66110-M42	5/32	0.158	1/4	1-3/4
66112-M42	3/16	0.190	9/32	1-3/4
66114-M42	7/32	0.221	9/32	1-3/4
66116-M42	1/4	0.252	3/8	1-3/4
66118-M42	9/32	0.284	7/16	1-3/4
66120-M42	5/16	0.315	1/2	1-3/4
66122-M42	11/32	0.346	9/16	1-3/4
66124-M42	3/8	0.378	9/16	1-3/4

*Overall Tool Length Tolerances +/- .015

Square Rotary Punch Broaches

Material: M-2 HSS For Mild Steel Applications. Special Materials Available For More Difficult To Machine Alloys

***Overall Tool Length Tolerances +/- .015**



Square Rotary/Punch Broaches				
8mm - .315 Shank		Inch Square Size		
EDP #	Square Size	Across Flats +.001 / -.000	Max. Depth of Cut	Overall Length*
68004	1/16	0.063	1/8	1-1/4
68006	3/32	0.095	9/64	1-1/4
68008	1/8	0.127	3/16	1-1/4
68010	5/32	0.158	1/4	1-1/4
68012	3/16	0.190	9/32	1-1/4
68014	7/32	0.221	11/32	1-1/4
68016	1/4	0.252	3/8	1-1/4
68018	9/32	0.284	3/8	1-1/4
68020	5/16	0.315	3/8	1-1/4
68022	11/32	0.346	3/8	1-1/4
68024	3/8	0.378	3/8	1-1/4

Square Rotary/Punch Broaches				
1/2" - .500 Shank		Inch Square Size		
EDP #	Square Size	Across Flats +.001 / -.000	Max. Depth of Cut	Overall Length*
68106	3/32	0.095	9/64	1-3/4
68108	1/8	0.127	3/16	1-3/4
68110	5/32	0.158	1/4	1-3/4
68112	3/16	0.190	9/32	1-3/4
68114	7/32	0.221	11/32	1-3/4
68116	1/4	0.252	3/8	1-3/4
68118	9/32	0.284	7/16	1-3/4
68120	5/16	0.315	1/2	1-3/4
68122	11/32	0.346	9/16	1-3/4
68124	3/8	0.378	5/8	1-3/4
68128	7/16	0.441	5/8	1-3/4
68132	1/2	0.504	5/8	1-3/4
68136	9/16	0.567	3/4	1-3/4
68140	5/8	0.630	7/8	1-3/4

Use With:

- Screw Machines
- CNC Machines
- Swiss Machines

Other Shanks, Metric,
Square, Octagon &
Spline forms Available.
Please Call

1-800-247-2024
For More Information



Square Rotary/Punch Broaches				
3/4" - .750 Shank		Inch Square Size		
EDP #	Square Size	Across Flats +.001 / -.000	Max. Depth of Cut	Overall Length*
68532	1/2	0.504	5/8	2-3/4
68536	9/16	0.567	3/4	2-3/4
68540	5/8	0.630	3/4	2-3/4
68548	3/4	0.755	7/8	2-3/4



Square Rotary/Punch Broaches				
8mm - .315 Shank		Metric Square Size		
EDP #	Square Size	Across Flats +.001 / -.000	Max. Depth of Cut	Overall Length*
682015	1.5mm	0.0605	3/32	1-1/4
68202	2mm	0.0805	7/64	1-1/4
682025	2.5mm	0.101	5/32	1-1/4
68203	3mm	0.120	3/16	1-1/4
682035	3.5mm	0.139	3/16	1-1/4
68204	4mm	0.160	1/4	1-1/4
662045	4.5mm	0.179	1/4	1-1/4
68205	5mm	0.199	5/16	1-1/4
68206	6mm	0.238	3/8	1-1/4
68207	7mm	0.278	3/8	1-1/4
68208	8mm	0.319	3/8	1-1/4
68209	9mm	0.358	3/8	1-1/4
68210	10mm	0.398	1/2	1-1/4

Square Rotary/Punch Broaches				
1/2" - .500 Shank		Metric Square Size		
EDP #	Square Size	Across Flats +.001 / -.000	Max. Depth of Cut	Overall Length*
683015	1.5mm	0.0605	3/32	1-3/4
68302	2mm	0.0805	7/64	1-3/4
683025	2.5mm	0.101	5/32	1-3/4
68303	3mm	0.120	3/16	1-3/4
683035	3.5mm	0.139	3/16	1-3/4
68304	4mm	0.160	1/4	1-3/4
683045	4.5mm	0.179	1/4	1-3/4
68305	5mm	0.199	5/16	1-3/4
68306	6mm	0.238	3/8	1-3/4
68307	7mm	0.278	3/8	1-3/4
68308	8mm	0.319	3/8	1-3/4
68309	9mm	0.358	3/8	1-3/4
68310	10mm	0.398	1/2	1-3/4
68311	11mm	0.437	9/16	1-3/4
68312	12mm	0.476	5/8	1-3/4

The practical forming
length of a rotary/
punch broaching is
usually up to 1-1/2
times the size of the
broach (measured
across flats).

Adjustable Rotary Broach Holders

Accepts A Variety Of Shapes, Such As Internal Hex & Square Rotary Broaches

Rotary Broach Holders:

- Use on any type CNC, manual turning, milling or screw machine.

Holder and broaches are sold separately and available from stock for immediate delivery.

For optimal tool life in large production settings these broaches should be used with Rotary Broach Holders.

- The holder has an internal live spindle, which holds the cutting broach tool.
- The centerline of the cutting tool is offset at 1° from the centerline of the work piece.
- This 1° offset causes the broach to wobble creating a shearing effect as the broach is advanced into the work piece.

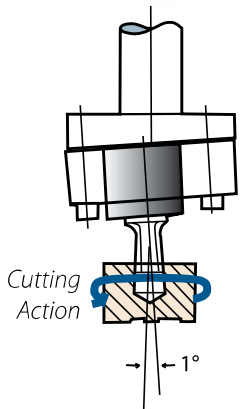

Diagram A

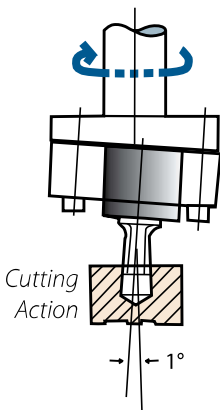

Diagram B

HEAVY DUTY

Adjustable Rotary Broach Holders

Use with 3/4 - .750 Broach Shank Diameter

EDP #	Overall Length	Holder Shank Dia.	Holder Shank Length	Broach Shank Depth
P-67072HDS	7-9/16	1-1/2	3	1.25
P-67076HD	7-9/16	1-3/4	3	1.25

Diagram A - Broaching a Rotating Work Piece

In a turning or screw machine, the holder is mounted stationary while its internal live spindle and the broach rotates after contact with the rotating work piece. At the appropriate feed, the workpiece is sheared by the pressure of the broach through a wobbling type action producing the polygon shape desired.

Diagram B - Broaching a Stationary Work Piece

In a vertical milling or drilling machine, the holder is mounted into and rotates with the machine spindle while its internal live spindle along with the broach remains stationary upon contact with the stationary work piece. While the machine spindle is rotating, the broach's pressure shears the polygon shape into the work piece with a wobbling type action.

Adjustable Rotary Broach Holders

Use with 8mm - .315 Broach Shank Diameter

EDP #	Overall Length	Holder Shank Dia.	Holder Shank Length	Broach Shank Depth
P-67040	3-27/64	5/8	1-1/2	9/16
P-67048S	3-59/64	3/4	2	9/16

Adjustable Rotary Broach Holders

Use with 1/2 - .500 Broach Shank Diameter

EDP #	Overall Length	Holder Shank Dia.	Holder Shank Length	Broach Shank Depth
P-67048	4-17/32	3/4	2	.742
P-67064	4-17/32	1	2	.742
P-67068	5-17/32	1-1/4	3	.742
P-67072	5-17/32	1-1/2	3	.742

HASSAY SAVAGE ROTARY TOOL HOLDER SET-UP PROCEDURE

For Internal Rotary Holders

1. Place the Rotary Tool Holder in the Turret (Lathe) or Tool Holder (Milling) depending on the application which fits your needs.
2. Mount the Set Up Plug or Punch Broach in the spindle of the Rotary Tool Holder and take care that the Plug or Punch is bottomed out in the spindle before tightening the set screw on the Holder's Spindle.
3. Drill and Ream a hole to the proper diameter (.001 larger) for the Set Up Plug in a piece of raw material with a lead chamfer .010-.015 larger than the cross points dimension of the Punch being used. If using the Punch Broach for centering, drill and ream the hole to the diameter of the cross point's dimension.
4. Loosen the 2 cap screws 2-3 turns on the face to generate 3/16 space between the flange portion of the Holder so that it is easily movable in the cup of your hand.
5. Advance the Rotary Tool Holder with the inserted Plug or Punch to .030 away from the part while holding the holder flush against the flange.
6. By hand, insert the Plug or Punch into the reamed hole.
7. Advance the turret or tool holder until the holder and tool is fully engaged in the hole
8. With the Plug or Punch still engaged in the hole, rotate the broach by hand in the hole while tightening the 2 cap screws.
9. Retract the turret or tool holder out of the reamed hole.
10. Remove the set up plug (If using one) and replace with the Punch Broach making sure the Punch Broach is bottomed out in the holder the same as in step 2.

11. See Next Page for Set-Up Plugs!

See Live Set-Up online at www.hassay-savage.com/resource-center under Hex Rotary Broach Holder Set-Up.

Rotary Broaching Set-Up Plugs

Standard Plugs - For Hex Broach Set-Up Only

Rotary Broaching Set-Up Plugs*

8mm Shank Metric

EDP #	Size	Plug Dia. (-.001 in.)	Shank Dia. (-.0050 in.)	Depth of Plug (in.)	OAL Overall Length (in.)
67008	1/8	0.129	8mm	5/16	1-1/4
67012	3/16	0.193	8mm	5/16	1-1/4
67016	1/4	0.257	8mm	5/16	1-1/4
67020	5/16	0.321	8mm	3/8	1-1/4
67024	3/8	0.387	8mm	1/2	1-1/4
67032	1/2	0.515	8mm	1/2	1-1/4

We can also supply you with custom turned diameters for your exact drill and bore size when repeatable set-ups are required for your job on a continuous basis, for both hex and square applications.

These will all come with the standard lengths and shank diameters of: 8mm, .500 and .750.

Contact our **CUSTOMER SERVICE DEPARTMENT** at **800-247-2024** for pricing and **24 hour delivery service**.



Rotary Broaching Set-Up Plugs*

1/2 Shank American Standard Inch

EDP #	Size	Plug Dia. (-.001 in.)	Shank Dia. (-.0050 in.)	Depth of Plug (in.)	OAL Overall Length (in.)
67112	3/16	0.193	.500	5/16	1-3/4
67116	1/4	0.257	.500	5/16	1-3/4
67124	3/8	0.387	.500	5/16	1-3/4
67132	1/2	0.515	.500	1/2	1-3/4
67140	5/8	0.643	.500	1/2	1-3/4

Rotary Broaching Set-Up Plugs*

3/4 Shank American Standard Inch

EDP #	Size	Plug Dia. (-.001 in.)	Shank Dia. (-.0050 in.)	Depth of Plug (in.)	OAL Overall Length (in.)
67524	3/8	0.387	.750	1/2	2-3/4
67532	1/2	0.515	.750	1/2	2-3/4
67540	5/8	0.643	.750	3/4	2-3/4
67548	3/4	0.771	.750	3/4	2-3/4

* Stock inventories are standard diameter gauge-plugs with specifications to use in standard holders.

Swiss Style Rotary Punch Broaches - 28mm OAL

Applications with M2 and PM-M4 Materials - Medical, Dental & Aerospace

- Consistent High-Tolerance Forms for Long Production Runs!
- Superb Surface Finishes!
- Outstanding Tool Life in Stainless & Titanium!
- Special Sizes, Special Tolerances in Less Than 5 Days



Hexagonal Rotary/Punch Broaches

.315 Shank American Standard Inch

EDP # M-2*	EDP # PM-M-4*	Hex Size	Across Flats (+/- .0002)	Max Depth of Cut	OAL Overall Length
76002	77002	0.051	0.0510	5/64	28mm
76004	77004	1/16	0.0645	3/32	28mm
76005	77005	5/64	0.0801	7/64	28mm
76006	77006	3/32	0.0958	9/64	28mm
76007	77007	7/64	0.1113	5/32	28mm
76008	77008	1/8	0.1270	3/16	28mm
76009	77009	9/64	0.1426	7/32	28mm
76010	77010	5/32	0.1585	1/4	28mm
76012	77012	3/16	0.1895	9/32	28mm
76014	77014	7/32	0.2207	11/32	28mm
76016	77016	1/4	0.2520	3/8	28mm

* M-2 for use with mild steel (HSS)

* PM-M4 for use with stainless, titanium & other high alloy steel

Hexagonal Rotary/Punch Broaches

.315 Shank Metric

EDP # M-2*	EDP # PM-M-4*	Hex Size	Across Flats (+/- .0002)	Max Depth of Cut	OAL Overall Length
762015	772015	1.5mm	0.0610	3/32	28mm
76202	77202	2mm	0.0807	5/32	28mm
762025	772025	2.5mm	0.1004	5/32	28mm
76203	77203	3mm	0.1201	3/16	28mm
762035	772035	3.5mm	0.1398	3/16	28mm
76204	77204	4mm	0.1595	1/4	28mm
762045	772045	4.5mm	0.1792	1/4	28mm
76205	77205	5mm	0.1989	5/16	28mm
76206	77206	6mm	0.2382	3/8	28mm

* M-2 for use with mild steel (HSS)

* PM-M4 for use with stainless, titanium & other high alloy steel

This Swiss Style Tooling Designed for Holders on Page 25

Swiss Style Non-Adjustable Holders

High Performance Results, Quality, And Consistent Tool Life That Keeps Machines Running Longer

Swiss Style Holders

- No Center Indicating Required – Self-Centering
- Smaller Head Diameter Eliminates Interference on Tool Blocks
- Longer Shank Can Be Cut To Proper Length
- Short Head Length For Limited Back Work Space
- Built In Wobble Cutting Feature 1° Angle
- Heavy Duty Bearing Takes 2,250 lbs. Pushing Force
- Swiss Made Quality High-Precision
- Fits Most Swiss Type Tool Blocks & Gang Machines
- Excellent for Aerospace, Medical Part / Bone Screw & Dental Part Production Applications
- Recommended profile range for this holder series is 0.050" to 0.375"
- Maintenance-Free Operation

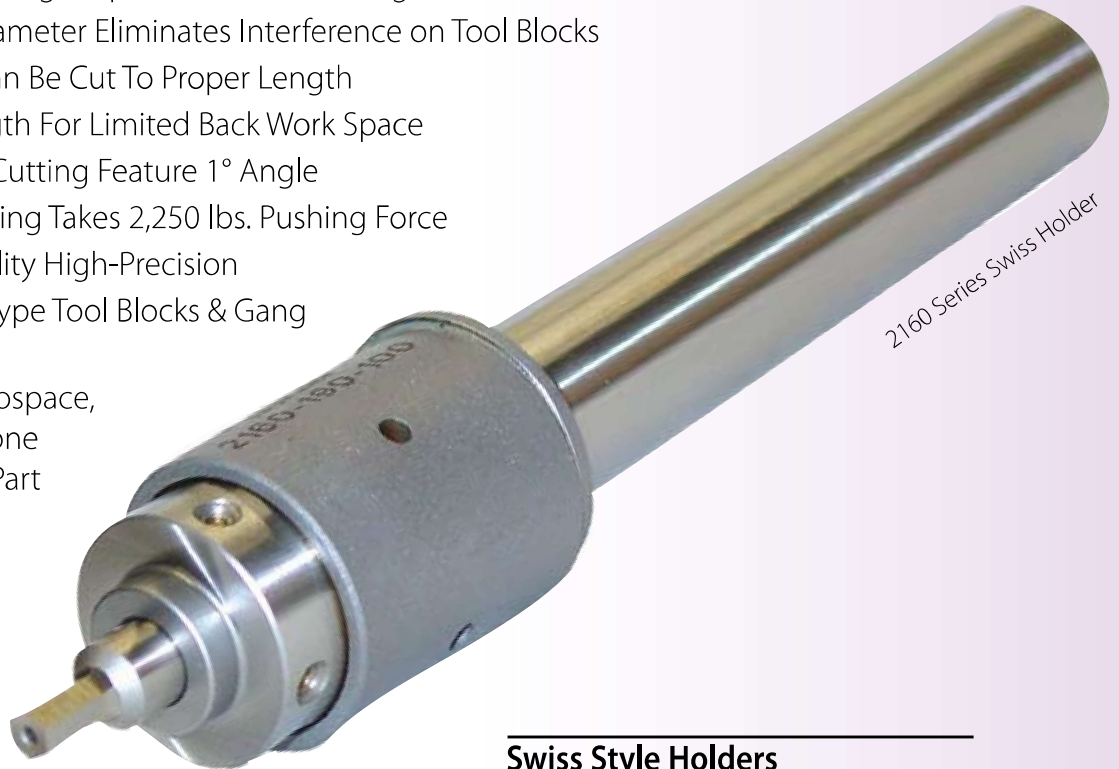

Swiss Style Holders

Holds 8mm Shank/Max. Push Force 2,250 lbs.

EDP #	D	L	AS/Metric
HSP-2160-158-038	5/8	1-1/2	inch
HSP-2160-190-100	3/4	4	inch
HSP-2160-254-120	1	4-3/4	inch
HSP-2160-120-038	12mm	38mm	metric
HSP-2160-140-038	14mm	38mm	metric
HSP-2160-160-038	16mm	38mm	metric
HSP-2160-200-100	20mm	100mm	metric
HSP-2160-220-100	22mm	100mm	metric
HSP-2160-250-120	25mm	120mm	metric

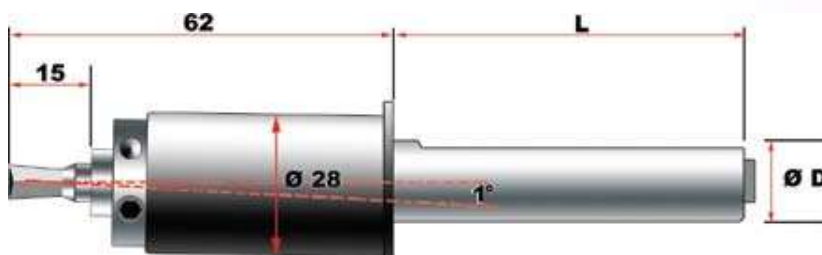

Use Recommendations

Part Preparation:

- The diameter of the pre-drilled hole should be larger than the measurement across the flats on the broach.
- Drill the hole 20% deeper than desired Depth of Cut for chip clearance.
- Countersink with a 90° lead chamfer slightly larger than the largest dimension of the broach face (distance across points) for lead of the broach.

Centering the Broach:

The most critical component in running these tools is having the broach centered as close as possible to the centerline of the work piece. Improper centering will cause uneven hole configurations, oversize holes, spiraling, and excessive cutter/holder wear.

- It is necessary to align the end of the broach tool to the centerline of the work piece diameter by means of adjusting the screws located on the sides of the holder, and the use of set-up plugs.
- Alignment instructions are included with purchase of the tool holder.

Speeds and Feeds:

Rotational speed (RPM) has a direct effect on cutting speed and tool life.

- Start at 800 RPM with a feed rate of .016 times the size of the broach in inches for a feed rate in IPR units.

Example: The feed rate for a ¼" rotary punch broach would be
 $0.016 \times .250 = .004/\text{rev.}$

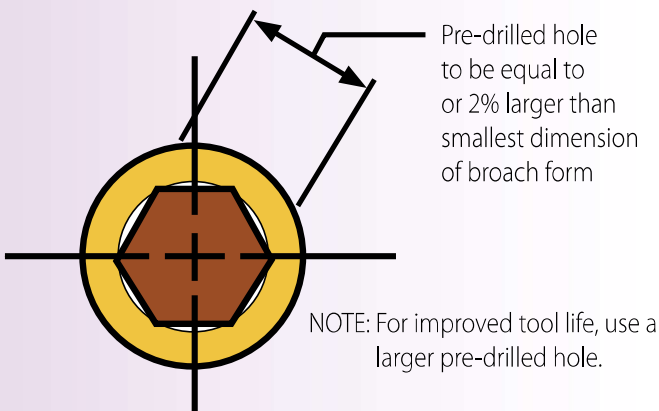

Broach Tool Material:

Broaches are customarily manufactured from M-2 high speed steel. This material provides the required edge toughness for standard operations, which do not generate enough heat to effect tool life in machining most metals. However, for broaching materials such as ductile iron, tool steel, stainless steels, titanium alloys, or nickel-cobalt alloys, a cobalt or PM-4 (powdered metal) broach would be recommended for optimal tool life. Coatings are also available.

Internal Example

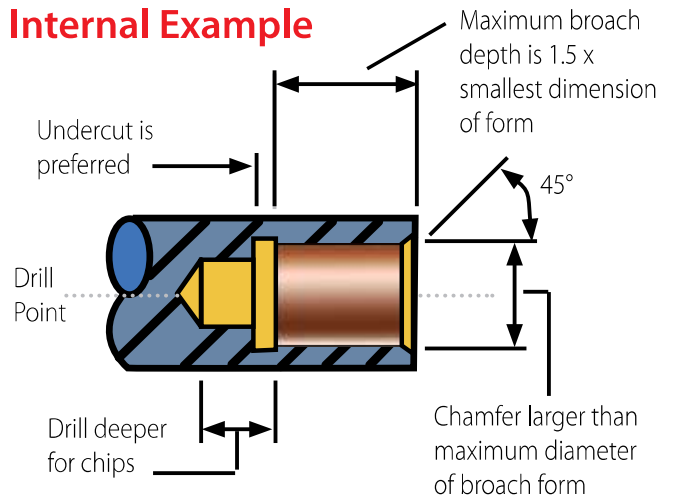

Cutting Principle

- The tool is held at a 1° angle relative to the part centerline.
- The face of the broach tool is the pivot of the 1° angle and is placed on centerline with the part.
- The cutting edge is kept on center and the rest of the tool oscillates around the part centerline with a wobble effect.
- With the faces of the tool and part are at a relative 1° angle, only the leading point of the tool is cutting and not the entire tool profile.
- The wobble effect moves the leading edge to rotate in and out of the cut like a cam.
- It shears the shape into the part with a scalloping effect as it advances forward.
- This reduces the required thrust force up to 80% when it is at the optimum feed.
- Venting can be added to broach to relieve pressure.



Hole Preparation Examples

Hex: $B \times 1.02$
 = Pre-drilled hole, 2% larger
 s.c.* = $B \times 1.1547$

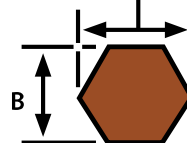

*s.c. = sharp corners

Square: $B \times 1.10$
 = Pre-drilled hole, 10% larger
 s.c.* = $B \times 1.4142$

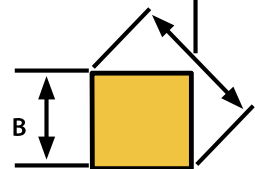

Index Broaching

An Alternative To Full Form Rotary Broaching

Index Broaching to Generate Full Polygon Forms

This broaching process involves a stationary spindle with orientation and lock capabilities. Once hole preparation is completed, then it is punched with a partial form of the shape that is to be generated. The tool form is indexed on a CNC machine by making imprints of the tool to the proper depth while the part is created to the full form desired.

Index Broaching can be performed on multiple machining applications. For instance, the **CNC machining centers** are the most common for Index Broaching:

- Lathes
- Swiss Style Machines
- Vertical Machining Centers

Typical applications include:

- Hexagonal
- Double Hexagonal
- 6 Lobe / Hexalobe
- Square
- Keyways / Slots / Splines

Required Tooling Includes:

- 90° Spot / Chamfer Tool
- Desired Pilot Drill
- Index Punch Broach



BASIC PRINCIPLES OF THE PROCEDURE

CNC Turning Machine

The CNC Turning Center performs each of these operations on the work piece before the Index Broach makes contact with the work piece.

- Face off the work piece.
- Countersink a pilot hole for the drill bit, slightly larger than the across corner dimensions of the broach.
- Drill pilot hole approximately 2 percent larger than the size across the flats.
- Hole is now prepared for Index Broach.

Why Hassay Savage Index Broaches?

- Consistent High-Tolerance Forms for Longer Production Runs!
- Superb Surface Finishes!
- Outstanding Tool Life in Stainless & Titanium!
- Special Sizes, Special tolerances in Less Than 5 Days!
- Hassay Savage Broaches Made to + / - .0002 Tolerance!
- Produce bone screws to + / - .0005 Tolerance!
- Material specification & superior heat treating assures quality of every Index Broach!
- Cobalt Base High Speed Broach Blanks in Most Standard Sizes In Stock for **FAST DELIVERY!**

Hassay Savage Index Broaches for:

- Medical & Dental Part Manufacturing
- Aerospace / Aircraft
- Automotive
- Fasteners
- Firearms & Munitions
- Electronics
- Plastics
- Communication Systems

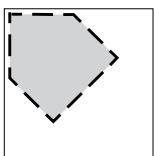

Single Point Square Form

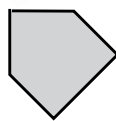

Single Point Index Broach

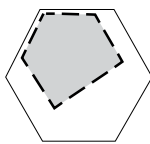

Single Point Hex Broach

Index Broaching & Holders

Hex and Hexalobe

2 or 4 Point Hex Broach Cutting Process

- Hole preparation completed with chamfer & proper pilot hole size.
- Machine spindle locked
- Punch enters the work piece, cutting the work piece, then retracts.
- The machine spindle indexes 60° then locks.
- The punch enters the work piece a second time, cutting the work piece, then retracts.
- Machine spindle indexes 60° then locks.
- Punch enters for a third and final imprint.
- Drill or boring bar used to make pilot hole can re-enter cut and remove ribbons and chips formed inside the cut.

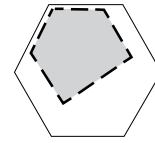

Single Point Hex Broach

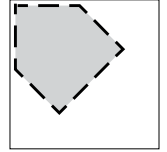

Single Point Square Form

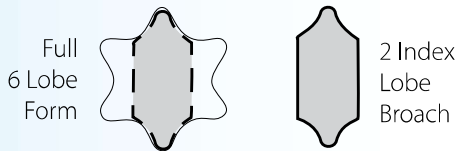
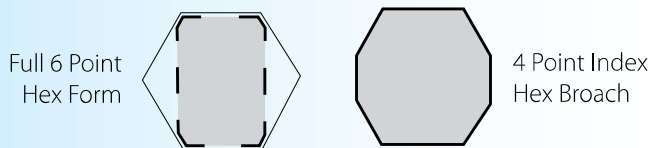
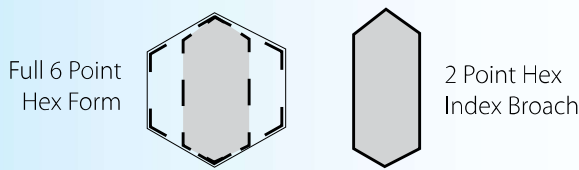

2 Point Hex Broach Cutting Procedure

is effective for broaching materials with higher tensile strength and relieves overall pressure during the process.

4 Point Hex Broach Cutting Procedure is effective for index broaching titanium and stainless steel materials to help improve better tolerances and surface finishes in the finished part.

6 Lobe Hexalobe Broach Cutting Procedures are similar procedures as 2-point or 4-point broach cutting. The process reduces overall pressure, improves tolerances and surface finishes. Ideal for automated production.

Static Index Punch Broach Holders

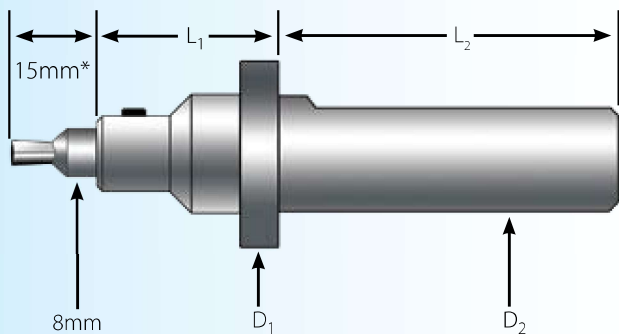

*Only applies when 8mm series broaches are used.

Punch Holders

EDP #	D1	D2	L1	L2
HSBH-158250-125-8	1.00"	.625"	1.25"	2.5"
HSBH-190250-125-8	1.00"	.750"	1.25"	2.5"
HSBH-200250-125-8	1.00"	20mm	1.25"	2.5"
HSBH-220250-125-8	1.00"	22mm	1.25"	2.5"
HSBH-254250-125-8	1.10"	1.00"	1.25"	2.5"

These Static Holders can also be used for Full Form Hex Broaches up to 1/4" / 7mm

Quick Change ER Collet Punch & Index Broach ER Holder Systems For Swiss and CNC Machining

When orientation and concentricity of an internal polygon profile is crucial, an ER holder can be used to securely hold a punch or index broach tool and accurately align the tool to center, while ensuring perfect alignment of the profile orientation. **These Quick Change Holders can be preset and reloaded in seconds.**

Punch Broach / Boring Adaptors & Nuts

EDP #	ER Size	Bore Dia.	Nut Tread
HSP-PA16-25001	ER16	.250	M19 x 1mm Nut & Locator Pin
HSP-PA16-31501	ER16	8mm	M19 x 1mm Nut & Locator Pin
HSP-PA20-25001	ER20	.250	M24 x 1mm Nut & Locator Pin
HSP-PA20-31501	ER20	8mm	M24 x 1mm Nut & Locator Pin

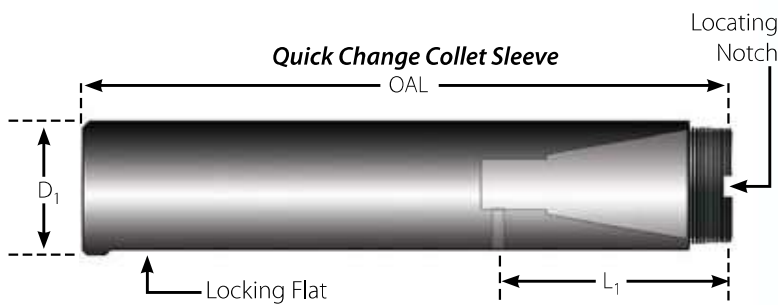
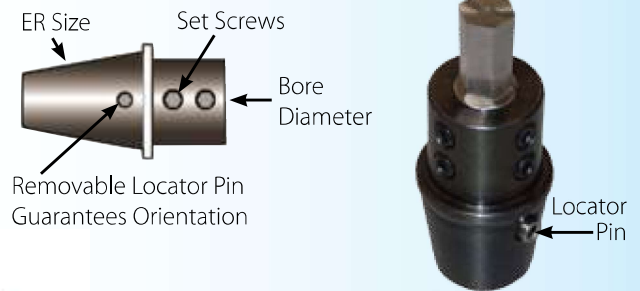

Quick Change Collet Sleeves

For SHANK ONLY Holders

EDP #	Collet	D1	L1	OAL
HSP-CS16-160500	ER16	.500	1.1	4.5
HSP-CS16-160625	ER16	.625	1.1	4.5
HSP-CS16-160750	ER16	.750	1.1	4.5
HSP-CS16-160787	ER16	20mm	28mm	71mm
HSP-CS16-160866	ER16	22mm	28mm	118mm
HSP-CS16-160984	ER16	25mm	28mm	95mm
HSP-CS16-161000	ER16	1"	1.1	4.5
HSP-CS20-200750	ER20	.750	1.2	4.5
HSP-CS20-200866	ER20	22mm	30mm	114mm
HSP-CS20-201000	ER20	1.00	1.2	4.5
HSP-CS20-201250	ER20	1.250	1.2"	4.5
HSP-CS20-201260	ER20	32mm	30mm	118mm

TO REQUEST A QUOTE PLEASE COPY AND FAX THIS PAGE TO 413-863-2714

Just Some of the Shapes You Can Broach

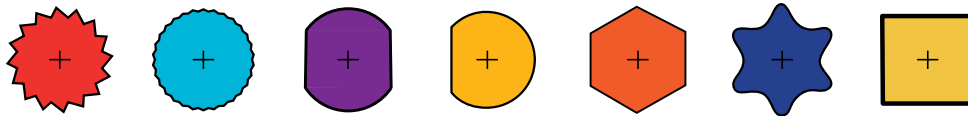

BROACH REQUIREMENTS

Size/Shape _____ Depth of Cut _____
 Tolerance +/- _____
 Desired Broach Shank Size _____
 Material to be Machined _____
 Type of Machine _____
 Type of Holder _____

CONTACT INFORMATION

Contact Name _____
 Company Name _____
 Address _____
 Phone Number _____
 Fax Number _____
 Email _____

Inch Square & Full Square Push Broaches

Designed for one pass finishing when used with • Arbor • Hydraulic Press • Vertical Broaching

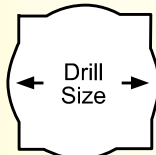

Standard Square

Inch Square Push Broaches 1/8" - 1"							Standard Inch			
Size Square	EDP No.	Tolerance	Dimension Across Corners	Pilot Diameter	Drill Size	Broach Length	Length of Cut		Pressure for Max.L/C (lbs.)	
							Min.	Max.		
1/8	13008	.1250 - .1260	.1750 - .1770	.1280 - #30		4-5/8	3/16	1/2	700	
5/32	13010	.1565 - .1575	.2180 - .2200	.1585 - #21		5-5/8	1/4	1/2	800	
3/16	13012	.1880 - .1890	.2620 - .2640	.1930 - #10		5-1/16	1/4	5/8	1,120	
7/32	13014	.2190 - .2200	.3050 - .3070	.2275 - #1		6-7/8	1/4	3/4	1,580	
1/4	13016	.2505 - .2515	.3500 - .3520	.2651 - 17/64		7	1/4	3/4	1,740	
9/32	13018	.2815 - .2825	.3930 - .3950	.2964 - 19/64		7-1/4	3/8	1	2,300	
5/16	13020	.3130 - .3140	.4370 - .4390	.3276 - 21/64		8-1/8	3/8	1	2,630	
11/32	13022	.3440 - .3450	.4810 - .4830	.3589 - 23/64		9-5/8	3/8	1-1/4	3,050	
3/8	13024	.3755 - .3765	.5230 - .5250	.3901 - 25/64		9-7/8	3/8	1-1/4	3,625	
13/32	13026	.4065 - .4075	.5680 - .5700	.4212 - 27/64		10-7/8	1/2	1-3/8	5,200	
7/16	13028	.4385 - .4395	.6110 - .6130	.4526 - 29/64		11-3/8	1/2	1-3/8	5,700	
15/32	13030	.4690 - .4700	.6560 - .6580	.4995 - 1/2		12-1/2	1/2	1-3/8	5,900	
1/2	13032	.5005 - .5015	.6970 - .6990	.5307 - 17/32		12-5/8	1/2	1-3/8	6,000	
9/16	13036	.5630 - .5640	.7860 - .7880	.5932 - 19/32		14-7/8	1/2	1-1/2	6,200	
5/8	13040	.6260 - .6270	.8710 - .8730	.6557 - 21/32		16-13/16	5/8	1-5/8	7,100	
11/16	13044	.6885 - .6895	.9610 - .9630	.7495 - 3/4		18-1/2	5/8	1-5/8	7,300	
3/4	13048	.7510 - .7520	1.0450 - 1.0470	.8120 - 13/16		18-7/8	5/8	1-5/8	8,600	
7/8	13056	.8765 - .8775	1.2280 - 1.0300	.9370 - 15/16		22-3/4	1/2	2	12,000	
1	13064	1.0020 - 1.0030	1.4030 - 1.4050	1.0932 - 1-3/32		24-1/2	1/2	2	12,500	

Metric Square Push Broaches 4mm- 25mm							Metric			
Size Square	EDP No.	Tolerance	Dimension Across Corners	Pilot Diameter	Drill Size	Broach Length	Length of Cut		Pressure for Max.L/C (lbs.)	
							Min.	Max.		
4mm	17001	.1580 - .1585	.2080 - .2090	.1655 - 4.2 mm		5-9/16	5/16	5/8	1,000	
5mm	17002	.1973 - .1983	.2645 - .2655	.2047 - 5.2 mm		6-7/8	3/8	3/4	1,580	
6mm	17003	.2367 - .2377	.3295 - .3300	.250 - 6.35 mm		7	3/8	3/4	1,740	
8mm	17004	.3155 - .3165	.4405 - .4410	.3267 - 8.3 mm		8-3/16	7/16	7/8	2,500	
10mm	17005	.3942 - .3952	.5435 - .5445	.4057 - 10.3 mm		10-7/8	1/2	1	2,800	
12mm	17006	.4729 - .4739	.6540 - .6550	.4921 - 12.5 mm		12-1/2	5/8	1-1/4	3,625	
14mm	17007	.5517 - .5527	.7700 - .7710	.5905 - 15.0 mm		14-7/8	3/4	1-1/2	6,200	
16mm	17008	.6310 - .6320	.8780 - .8790	.6693 - 17.0 mm		16-13/16	7/8	1-5/8	7,100	
18mm	17009	.7092 - .7102	.9880 - .9890	.7874 - 20.0 mm		18-1/2	7/8	1-3/4	8,200	
20mm	17010	.7879 - .7889	1.0990 - 1.1000	.8661 - 22.0 mm		18-7/8	7/8	1-3/4	9,500	
22mm	17011	.8666 - .8676	1.2110 - 1.2120	.9448 - 24.0 mm		23-1/4	7/8	1-3/4	9,700	
24mm	17012	.9454 - .9464	1.3170 - 1.3180	1.0236 - 26.0 mm		24-9/16	7/8	1-3/4	10,000	
25mm	17013	.9848 - .9858	1.3730 - 1.3740	1.0630 - 27.0 mm		24-9/16	7/8	1-3/4	10,500	

Full Square Push Broaches 3/16" - 1/2"							Standard Inch			
Size Square	EDP No.	Tolerance	Dimension Across Corners	Pilot Diameter	Drill Size	Broach Length	Length of Cut		Pressure for Max.L/C (lbs.)	
							Min.	Max.		
3/16	14012	.1880 - .1890	.2628 - .2632	.1870 - 3/16		6-1/4	3/16	1/2	1,200	
1/4	14016	.2505 - .2515	.3513 - .3517	.2495 - 1/4		8-5/8	1/4	5/8	1,600	
5/16	14020	.3120 - .3140	.4375 - .4380	.3120 - 5/16		10-1/4	1/4	3/4	2,300	
3/8	14024	.3755 - .3765	.5243 - .5247	.3745 - 3/8		12-1/4	3/8	1	3,750	
7/16	14028	.4385 - .4395	.6170 - .6180	.4370 - 7/16		14-7/16	3/8	1	3,950	
1/2	14032	.5005 - .5015	.6980 - .6990	.4995 - 1/2		14-7/16	3/8	1	5,000	

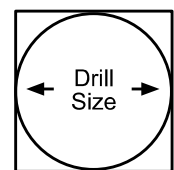

Full Square

Modified Standard Inch and Metric Tolerances are Available with Expedited Delivery!

Hexagonal Push Broaches

Hexagonal Push Broaches 1/8" - 1"						Standard Inch			
Size Square	EDP No.	Dimension Tolerance	Dimension Across Corners	Pilot Diameter	Drill Size	Broach Length	Length of Cut Min.	Length of Cut Max.	Pressure for Max.L/C (lbs.)
1/8	12008	.1255 - .1260	.1450 - .1470	.1245 -	1/8	4-5/8	3/16	3/8	120 lbs
5/32	12010	.1565 - .1570	.1800 - .1820	.1557 -	5/32	5-1/2	1/4	1-1/2	340 lbs
3/16	12012	.1880 - .1890	.2145 - .2155	.1870 -	3/16	5-9/16	1/4	5/8	520 lbs
7/32	12014	.2190 - .2200	.2500 - .2520	.2182 -	7/32	6	1/4	3/4	890 lbs
1/4	12016	.2505 - .2515	.2865 - .2875	.2495 -	1/4	6-1/2	1/4	3/4	1,250 lbs
9/32	12018	.2815 - .2825	.3220 - .3240	.2807 -	9/32	7-3/4	3/8	1	1,650 lbs
5/16	12020	.3130 - .3140	.3580 - .3590	.3120 -	5/16	8-1/4	3/8	1	2,175 lbs
11/32	12022	.3440 - .3450	.3950 - .3970	.3432 -	11/32	8-1/4	3/8	1-1/4	3,500 lbs
3/8	12024	.3755 - .3765	.4300 - .4310	.3745 -	3/8	9	3/8	1-1/4	3,700 lbs
13/32	12026	.4065 - .4075	.4670 - .4690	.4057 -	13/32	10	1/2	1-3/8	4,100 lbs
7/16	12028	.4385 - .4395	.5020 - .5030	.4370 -	7/16	10-3/4	1/2	1-3/8	4,575 lbs
15/32	12030	.4690 - .4700	.5390 - .5410	.4682 -	15/32	12-3/8	1/2	1-3/8	4,700 lbs
1/2	12032	.5005 - .5015	.5740 - .5750	.4995 -	1/2	12-1/2	1/2	1-3/8	5,300 lbs
9/16	12036	.5630 - .5640	.6480 - .6500	.5620 -	9/16	14-1/4	1/2	1-1/2	6,700 lbs
5/8	12040	.6260 - .6270	.7170 - .7185	.6245 -	5/8	16-7/8	5/8	1-5/8	7,250 lbs
11/16	12044	.6880 - .6890	.7930 - .7950	.6870 -	11/16	17	5/8	1-5/8	9,300 lbs
3/4	12048	.7510 - .7520	.8610 - .8625	.7495 -	3/4	17-7/8	5/8	1-5/8	13,500 lbs
7/8	12056	.8755 - .8765	1.0060 - 1.0075	.8745 -	7/8	18-7/8	5/8	1-5/8	18,500 lbs
1	12064	1.0020 - 1.0030	1.1520 - 1.1530	.9995 -	1	19-7/8	5/8	1-5/8	20,050 lbs

Hexagonal Push Broaches 4mm - 25mm						Metric			
Size Square	EDP No.	Dimension Tolerance	Dimension Across Corners	Pilot Diameter	Drill Size	Broach Length	Length of Cut Min.	Length of Cut Max.	Pressure for Max.L/C (lbs.)
4 mm	12104	.1580 - .1585	.1820 - .1830	.1575 -	4.0	5-1/2	1/4	1/2	340 lbs
5 mm	12105	.1973 - .1983	.2270 - .2280	.1968 -	5.0	6	1/4	3/4	890 lbs
6mm	12106	.2367 - .2377	.2730 - .2740	.2362 -	6.0	6-1/2	1/4	3/4	1,250 lbs
7 mm	12107	.2760 - .2770	.3180 - .3190	.2756 -	7.0	7-3/4	3/8	1	1,650 lbs
8mm	12108	.3155 - .3165	.3634 - .3644	.3150 -	8.0	8-1/4	3/8	1	2,175 lbs
10 mm	12110	.3942 - .3952	.4543 - .4553	.3937 -	10.0	10	1/2	1	4,100 lbs
12 mm	12112	.4729 - .4739	.5452 - .5462	.4724 -	12.0	12-3/8	1/2	1-3/8	4,700 lbs
14 mm	12114	.5517 - .5527	.6332 - .6342	.5512 -	14.0	14-1/4	1/2	1-3/8	6,700 lbs
16 mm	12116	.6310 - .6320	.7248 - .7258	.6290 -	16.0	16-7/8	5/8	1-1/2	7,250 lbs
18 mm	12118	.7092 - .7102	.8150 - .8160	.7087 -	18.0	17	5/8	1-5/8	9,400 lbs
20 mm	12120	.7879 - .7889	.9049 - .9059	.7874 -	20.0	17-7/8	5/8	1-5/8	14,150 lbs
22 mm	12122	.8666 - .8676	.9958 - .9968	.8661 -	22.0	18-7/8	5/8	1-5/8	18,500 lbs
24 mm	12124	.9454 - .9464	1.0868 - 1.0878	.9449 -	24.0	19-7/8	5/8	1-5/8	20,500 lbs
25 mm	12125	.9848 - .9858	1.1323 - 1.1333	.9842 -	25.0	19-7/8	5/8	1-5/8	22,000 lbs

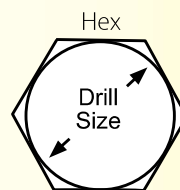

To select a **STANDARD BROACH** from Hassay Savage: **Choose** a tool, or set of tools that will produce the cut your finished part requires.

Specify

- EDP
- Size
- Brief Description

STANDARD PRODUCTS are fully maintained in finished goods inventory.

We can ship your order the same day it is placed.

Special widths and lengths are also available from semi-finished stock ground to your specifications with quick delivery.



SPECIAL SQUARE and HEXAGON BROACHES

If your application cannot be handled with the standard broaches listed, send us a sample or print of the part to be broached, and we will provide a quote.

Include the following data:

HOLE:

- Dimensions Before and After Broaching
- Tolerances
- Specify Cast, Drilled or Reamed
- Length of Cut Through Part Required

MATERIAL:

- Specifications
- Specify Bar, Cast or Forged Stock
- Rc Hardness Before Broaching

Davis Style Keyseating Broaches

KEYSEATING BROACHES

Hassay Savage HSS keyseating pull broaches are manufactured similar to the Davis AF Series cutters and are interchangeable.

- Cutter bars have 10° rake face, 5° backoff and 2° side-relief on all teeth.
- Broaches may be used on Davis model 4, 5, and 15 machines.
- Sizes range from 1/16" to 1" and 2mm to 25mm.
- For special applications contact our customer service **1-800-247-2024**

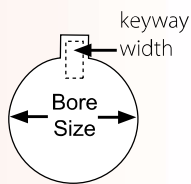

Why Hassay Savage Broaches Stand For Precision And Top Quality:

- The side relief eliminates drag in multiple-pass broaching.
- Tooth-relief, using Borazon™ wheels, improves surface finish and extends tool life.
- Precision grinding of the rake face insures consistent performance and free cutting action after several sharpenings.

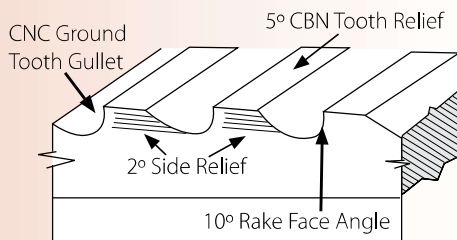

Davis Keyseat Puller Design

Keyseater Inch

1/16" - 1"

EDP No.	Broach Size	Keyway Width Tolerance (inches)	Dimensions Body Width x Height x Length	Length of Cut	
				Min.	Max.
10701	1/16	.0630 - .0640	3/16 x 3/8 x 16	5/8	1-7/8
10702	3/32	.0942 - .0952	3/16 x 7/16 x 16	5/8	1-7/8
10703	1/8	.1255 - .1265	3/16 x 7/16 x 16	5/8	1-7/8
10704	5/32	.1568 - .1578	3/16 x 1/2 x 16	5/8	1-7/8
10705	3/16	.1880 - .1890	3/16 x 9/16 x 16	5/8	1-7/8
10706	3/16	.1880 - .1890	3/16 x 3/4 x 20	5/8	3-1/8
10707	1/4	.2505 - .2515	1/4 x 3/4 x 16	5/8	1-5/8
10708	1/4	.2505 - .2515	1/4 x 3/4 x 20	5/8	3-1/8
10709	5/16	.3130 - .3140	5/16 x 7/8 x 16	1-1/16	3-3/16
10710	5/16	.3130 - .3140	5/16 x 7/8 x 20	1-1/16	5-3/16
10711	3/8	.3755 - .3765	3/8 x 7/8 x 16	1-1/16	3-3/16
10712	3/8	.3755 - .3765	3/8 x 7/8 x 20	1-1/16	5-3/16
10713	7/16	.4380 - .4390	7/16 x 1 x 16	1-1/16	3-3/16
10714	7/16	.4380 - .4390	7/16 x 1 x 20	1-1/16	5-3/16
10715	1/2	.5005 - .5015	1/2 x 1 x 20	1-1/16	5-3/16
10716	9/16	.5630 - .5640	9/16 x 1 x 20	1-1/16	5-3/16
10717	5/8	.6255 - .6265	5/8 x 1 x 20	1-1/16	5-3/16
10718	3/4	.7505 - .7515	3/4 x 1 x 20	1-1/16	5-3/16
10719	7/8	.8755 - .8765	7/8 x 1 x 20	1-1/16	5-3/16
10720	1	1.0005 - 1.0015	1 x 1 x 20	1-1/16	5-3/16

Keyseater Metric

2mm - 25mm

EDP No.	Broach Size	Keyway Width Tolerance (inches)	Dimensions Body Width x Height x Length	Length of Cut	
				Min.	Max.
11701	2 mm	.0792 - .0802	3/16 x 3/8 x 16	5/8	1-7/8
11702	3 mm	.1186 - .1196	3/16 x 7/16 x 16	5/8	1-7/8
11703	4 mm	.1580 - .1590	3/16 x 1/2 x 16	5/8	1-7/8
11704	5 mm	.1974 - .1984	5 mm x 1/2 x 16	5/8	1-7/8
11705	5 mm	.1974 - .1984	5 mm x 1/2 x 20	5/8	3-1/8
11706	6 mm	.2367 - .2377	6 mm x 5/8 x 16	5/8	1-7/8
11707	6 mm	.2367 - .2377	6 mm x 5/8 x 20	5/8	3-1/8
11708	8 mm	.3155 - .3165	8 mm x 7/8 x 16	1-1/16	3-3/16
11709	8 mm	.3155 - .3165	8 mm x 7/8 x 20	1-1/16	5-5/16
11710	10 mm	.3942 - .3952	10 mm x 7/8 x 16	1-1/16	3-3/16
11711	10 mm	.3942 - .3952	10 mm x 7/8 x 20	1-1/16	5-5/16
11712	12 mm	.4724 - .4730	12 mm x 1 x 20	1-1/16	5-5/16
11713	14 mm	.5517 - .5527	14 mm x 1 x 20	1-1/16	5-5/16
11714	16 mm	.6304 - .6314	16 mm x 1 x 20	1-1/16	5-5/16
11715	18 mm	.7092 - .7102	18 mm x 1 x 20	1-1/16	5-5/16
11716	20 mm	.7879 - .7889	20 mm x 1 x 20	1-1/16	5-5/16
11717	22 mm	.8666 - .8676	22 mm x 1 x 20	1-1/16	5-5/16
11718	24 mm	.9454 - .9464	24 mm x 1 x 20	1-1/16	5-5/16
11719	25 mm	.9848 - .9858	25 mm x 1 x 20	1-1/16	5-5/16

Tolerance considerations are based on preferred metric limits and fits
ANSI B4.2-1978

Custom corner radius, size specific and full radius cutters are available with form relief upon request.

500 & 600 Series Pull Type Broaches

Hassay Savage Supplies Pull Heads For 500 And 600 Series Broaches Upon Request. Call Us For Size And Delivery.

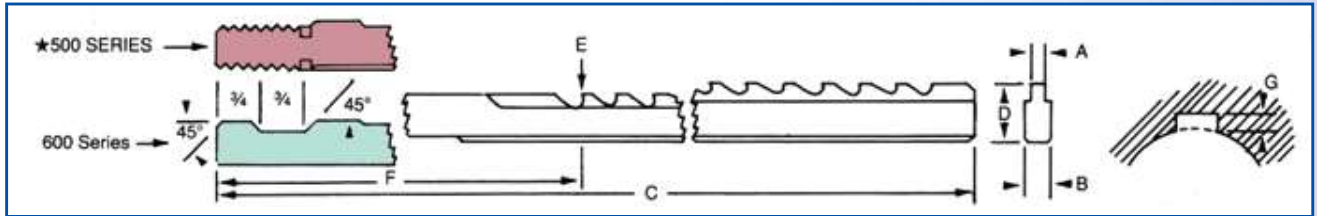

EDP No. 500 Series	EDP No. 600 Series	500 Series	600 Series	Nom. Dim.	A Decimal Dim.	Tolerance	Min. Hole Size	Min. Length Cut**	Max. Length Cut	B +.0000 -.0005	C	D ±.0005	E	F	G	No. of Cuts	Thread Size
33501	33601	501	601	1/16	.0635	+ / - .0005	3/8	3/8	1-1/4	.1552	20	.313	.271	7-3/16	.042	1	1/4 - 20
33502	33602	502	602	3/32	.0948	+ / - .0005	7/16	1/2	1-1/2	.1865	24	.367	.309	8-1/4	.058	1	5/16 - 18
33503	33603	503	603	3/32	.0948	+ / - .0005	5/8	5/8	2-1/2	.2490	33	.491	.433	10	.058	1	3/8 - 16
33504	33604	504	604	1/8	.1260	+ / - .0005	1/2	1/2	1-1/2	.2490	30	.438	.364	9	.074	1	3/8 - 16
33505	33605	505	605	1/8	.1260	+ / - .0005	7/8	5/8	2-1/2	.3115	36	.594	.520	10	.074	1	1/2 - 13
33506	33606	506	606	5/32	.1572	+ / - .0005	19/32	1/2	1-1/2	.2490	30	.525	.436	9	.089	1	3/8 - 16
33507	33607	507	607	5/32	.1572	+ / - .0005	23/32	5/8	2-1/2	.3115	33	.625	.536	10	.089	1	1/2 - 13
33508	33608	508	608	3/16	.1885	+ / - .0005	11/16	5/8	2-1/2	.3740	36	.581	.476	10	.105	1	1/2 - 13
33509	33609	509	609	3/16	.1885	+ / - .0005	15/16	11/16	3-1/2	.3740	36	.796	.691	10-11/16	.105	1	1/2 - 13
33510	33610	510	610	7/32	.2198	+ / - .0005	11/16	5/8	2-1/2	.3740	33	.557	.437	10	.120	1	1/2 - 13
33511	33611	511	611	11/32	.2198	+ / - .0005	15/16	11/16	3-1/2	.3740	42	.813	.693	11-1/16	.120	1	1/2 - 13
33512	33612	512	612	1/4	.2510	+ / - .0005	11/16	5/8	2-1/2	.3740	36	.612	.476	10	.136	1	1/2 - 13
33513	33613	513	613	1/4	.2510	+ / - .0005	1	11/16	4	.4990	45	.877	.741	11-13/16	.136	1	5/8 - 11
33514	33614	514	614	1/4	.2510	+ / - .0005	1-7/16	7/8	6	.6240	51	1.250	1.114	13-1/2	.136	1	3/4 - 10
33515	33615	515	615	9/32	.2828	+ / - .0005	7/8	11/16	4	.4990	45	.716	.564	11-5/8	.152	1	5/8 - 11
33516	33616	516	616	9/32	.2828	+ / - .0005	1-1/4	7/8	6	.4990	51	1.093	.941	13-1/2	.152	1	5/8 - 11
33517	33617	517	617	5/16	.3140	+ / - .0005	1	11/16	4	.4990	45	.908	.741	11-13/16	.167	1	5/8 - 11
33518	33618	518	618	5/16	.3140	+ / - .0005	1-5/16	7/8	6	.4990	51	1.158	.991	13-1/2	.167	1	5/8 - 11
33519	33619	519	619	3/8	.3765	+ / - .0005	1-1/16	11/16	4	.4990	45	.938	.739	11-13/16	.199	1	5/8 - 11
33520	33620	520	620	3/8	.3765	+ / - .0005	1-5/16	7/8	6	.4990	54	1.189	.990	13-1/2	.199	1	5/8 - 11
33521	33621	521	621	7/16	.4390	+ / - .0005	1-9/16	11/16	4	.6240	48	1.360	1.160	12	.230	1	3/4 - 10
33522	33622	522	622	7/16	.4390	+ / - .0005	2	1	8	.6240	48	1.611	1.496	15-5/8	.230	2	3/4 - 10
33523	33623	523	623	1/2	.5015	+ / - .0005	1-1/2	11/16	4	.6240	48	1.312	1.051	12	.261	1	3/4 - 10
33524	33624	524	624	1/2	.5015	+ / - .0005	1-1/2	1	8	.6240	48	1.377	1.246	16-1/2	.261	2	3/4 - 10
33525	33625	525	625	9/16	.5645	+ / - .0005	1-3/4	11/16	4	.6865	54	1.438	1.146	11-13/16	.292	1	1 - 8
33526	33626	526	626	9/16	.5645	+ / - .0005	1-5/8	1	8	.6865	51	1.391	1.245	16	.292	2	1 - 8
33527	33627	527	627	9/16	.5645	+ / - .0005	2-1/4	1-1/8	12	.8740	60	1.641	1.495	20	.292	2	1 - 8
33528	33628	528	628	5/8	.6270	+ / - .0005	1-7/8	11/16	4	.7490	60	1.625	1.301	12-3/16	.324	1	1 - 8
33529	33629	529	629	5/8	.6270	+ / - .0005	2-1/2	1	8	.8740	54	1.657	1.495	16-3/8	.324	2	1 - 8
33530	33630	530	630	5/8	.6270	+ / - .0005	2-1/4	1-1/8	12	.8740	57	1.657	1.495	20	.324	2	1 - 8
33531	33631	531	631	3/4	.7520	+ / - .0005	1-7/8	11/16	4	.8740	60	1.625	1.239	12-3/16	.386	1	1 - 8
33532	33632	532	632	3/4	.7520	+ / - .0005	2	1	8	.9990	60	1.688	1.495	16-3/8	.386	2	1-1/4 - 7
33533	33633	533	633	3/4	.7520	+ / - .0005	2-1/4	1-1/8	12	.9990	57	1.688	1.560	20	.386	3	1-1/4 - 7
33534	33634	534	634	7/8	.8770	+ / - .0005	2-1/4	11/16	4	1.1240	63	1.875	1.426	12-3/8	.449	1	1-1/4 - 7
33535	33635	535	635	7/8	.8770	+ / - .0005	2-1/4	1	8	1.1240	63	1.719	1.494	15-3/4	.449	2	1-1/4 - 7
33536	33636	536	636	7/8	.8770	+ / - .0005	2-1/4	1-1/8	12	1.1240	63	1.719	1.569	20	.449	3	1-1/4 - 7
33537	33637	537	637	1	1.0020	+ / - .0005	2-1/4	5/8	2-1/2	1.2490	63	1.750	1.239	10-1/2	.511	1	1-1/2 - 6
33538	33638	538	638	1	1.0020	+ / - .0005	2-1/4	7/8	6	1.2490	63	1.750	1.494	14-1/4	.511	2	1-1/2 - 6
33539	33639	539	639	1	1.0020	+ / - .0005	2-1/4	1-1/8	12	1.2490	60	1.750	1.580	20	.511	3	1-1/2 - 6

*600 Series designates notched-type shank **Minimum length of part recommended to prevent part from dropping in between teeth of broach

Custom Broaching Solutions

Save time, increase your productivity and profits with Hassay Savage Custom Broaching Solutions! Here are just a few samples of our innovative broaching solutions:

- **Broach your part right to finish tolerances**
- **Finish a shape right to specification in a CNC operation**
- **Nibble, shave, shear a geometry within a part**



Rectangle Punch
Radius Corners
with Witness Marks

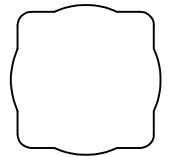

These and countless other possibilities can be obtained with the use of custom designed Hassay Savage Broaches. Whether it is to create an entire geometry or just complete an operation within a programmed, production machining operation, Hassay Savage can help you develop cost saving solutions for your production needs.

Broaching is no longer a stand alone operation. Take advantage of the full capabilities of your CNC Processing Equipment and finish your part by broaching within this process. It can be integrated into your current CNC production using custom designed broaches that can finish your parts right to specification without breaking set up or moving your part to a secondary operation. Our engineers can integrate the design and manufacturing process for your custom application and maintain total datum tolerance control of your parts.

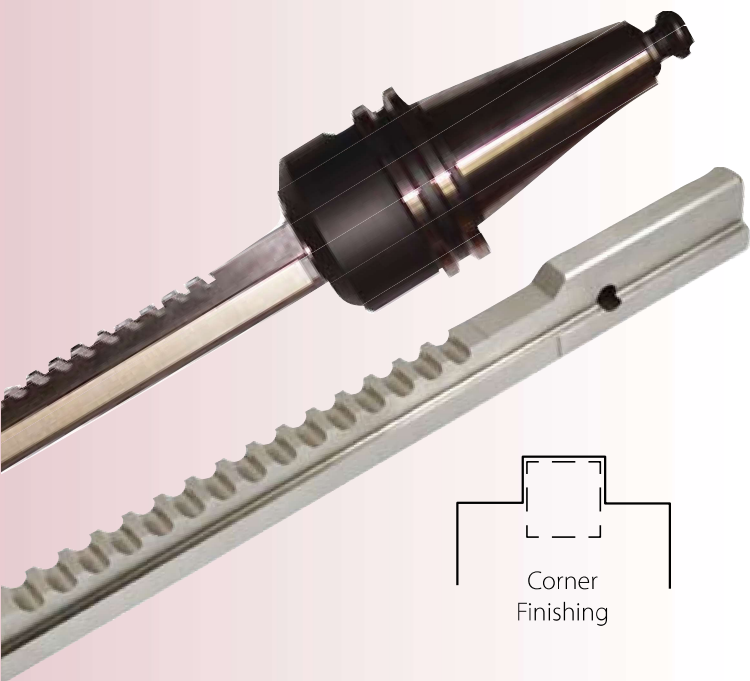

Typical Broach Applications May Include:

- Tooling Fixtures
- Gears
- Pulleys
- Keyways
- Rifling
- Special Geometric Shapes
- External Gears
- Flats
- Notches
- Serrations
- Slots
- Intricate contours
- Key Lock Slots
- Connecting Rods

We Routinely Assist The Following Industries:

- **Medical**
- **Orthopedic**
- **Dental**
- **Automotive**
- **Firearms**
- **Munitions**
- **Military**
- **Aircraft**
- **Aerospace**
- **Electronics**
- **Communications**
- **Plastics**

Selected Broaching Applications

The following list will give you an idea of the kind of first-rate special broaching that distinguishes our company world-wide.

Selected applications are:

- **Metering Valve:**

0.524" x 1.706" rectangle with 20" push broach: broached at Hassay Savage with 100% inspection for just-in-time shipments to OEM; job lot of 25,000 pieces/yr.

- **Control Vent Airframe:**

40 slots in rectangle chamber; 1.625" x 6.000"; broach was pull-type on horizontal machine; accuracy of 0.001 required throughout reference of all points; job lot of 100 units.

- **Printing guide Lever:**

19mm x 1,6mm rectangle with 610mm pull broach, bronze workpiece; limited production.

- **Wave Guide:**

1.345" x 2.848" x 36" pull broach; job lot of 500 pieces, on continuous basis.

- **Control Pin:**

Flats and radius slot; insert type slab broaches and radius slot broaching on vertical machine; high volume tumbler feed magazine.

- **Pliers:**

Set of three surface broaches to broach teeth of pliers; open clearance cut-off section; high volume run.

- **Collets:**

6 slots; 0.093 width; slotting broaches for cutting collet slots on vertical broach; high volume with a great variety of sizes using same broaches.

- **Ratchet Wrench:**

Elliptical set of holes for mechanism of ratchet; with a 2-piece construction broach for U.S. wrench manufacture.

- **Internal Spline Gear:**

22-tooth 36 spline pull broach; 24/48 diametrical pitch; 20° pressure angle; 2 million pieces per year.

- **Surgical Scissors:**

4 wide, 16 long surface broach, stainless steel workpiece; continuous medium volume.



Pictured: Custom broached parts.



Research and Development

Integration of design and manufacturing process at the prototype stage is critical!

Hassay Savage can save you time and money when our engineers are involved from the onset.

- State-of-the-art technology
- Understanding materials:
 - ferrous metals and alloys
 - non-ferrous metals
 - non-metallic materials
 - plastics and ceramics
 - wood products
- Successful broaching is knowing the capabilities of machining centers and flexible manufacturing systems
- We support partnership development

In affiliation with University Broaching Research Laboratories, we are working on:

- Expert systems for the automation of the broach design process.
- Integrated system for the automation for the near-net shape (pre-forming) manufacture of broaching tools.
- A knowledge-based system for yielding maximum allowable cutting force during broaching by creating exacting tooth geometry.
- Computer-aided process of down-loading machining programs to workstations by the actual routing process
- Procedures that reduce the cost of designing, manufacturing, and rebuilding broaches.

*The broach is an unsurpassed, unique tool that generates unique finish shapes in one pass. Broaching has a distinct advantage over other metal cutting operations because of its exacting precision, superb finish, faster production rates (as much as 5 to 10 times higher). **Wherever broaches are utilized, the result is improved quality and productivity.***

Using the Hassay Savage system gives you the best assurance in the industry!